

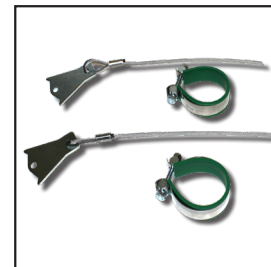

	Page
Oils and Lubricants	2
Lubrication Equipment (Grease & Oil)	6
Hose Reels	16
Pressure Test Equipment.....	21
Pneumatic Hose Assemblies.....	20
Automotive Hoses	26
Air Conditioning Products	27
Cable Ties, Hose Straps.....	33
Kits: Cap & Plug, O-Rings	35
Plugs	36
Oil Spill Kits	37
Fluid Power Gloves	38
Hose Cleaning Equipment.....	39
Thread Identification and Tool Kits.....	40
Pressure Cleaner Components	41
Hose Protection & Safety Devices	46



 **WARNING:** This product may contain chemicals known to the State of California to cause cancer, birth defects, or other reproductive harm. For more information please visit: www.p65warnings.ca.gov

LUBRICANTS

MINERAL BASED OILS AND GREASES

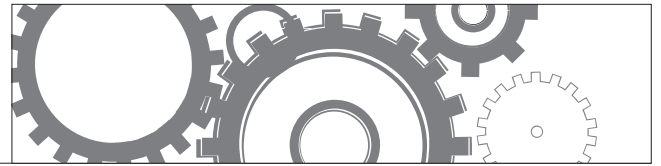

Hydraulic Oils:

- PIRTEK supply popular commonly used hydraulic fluids
- Available in ISO Grades 32,46 and 68
- All oils incorporate advanced performance additives to combat rust, corrosion and wear
- Meet or exceed major manufacturer's requirements
- Handy 2.5 gallon or 5 gallon pail or 55 gallon drums available
- High Viscosity HVI types available upon request



Automotive Fluids:

- Dexron®-III / Mercon® is a quality Automatic Transmission Fluid suitable for hydraulic controlled transmissions and retains fluidity within low temperatures.
- Available in a one gallon containers
- For other specialist requirements, please consult PIRTEK



Greases:

- NLGI No2 Lithium complex grease contains extreme pressure additives
- Recommended for extended lubrication intervals
- Suitable for wheel bearings (disc and drum brakes), chassis, construction and farm equipment
- Provides superior resistance to water wash out
- Good adhesive properties
- Has a smooth texture and is blue in color

PIRTEK LUBRICATION PRODUCTS								
Product Code	Description	12 Ounce	400 Gram	1 Quart	1 Gallon	2.5 Gallon	5 Gallon	55 Gallon
G10VATF	DEX/MERC Automatic Transmission Fluid				•			
VC14G2	Cerulean Lithium Grease NLGI No 2 14oz 400g		•					
VP14G2	Palladium Grease MoS ₂ NLGI No 2 14oz 400g		•					
G25P32	Oil - Hydraulic Oil 32 X 2.5 Gallon					•		
G50P32	Oil - Hydraulic Oil 32 X 5 Gallon						•	
G550P32	Oil - Hydraulic Oil 32 X 55 Gallon							•
G25P46	Oil - Hydraulic Oil 46 X 2.5Gallon					•		
G50P46	Oil - Hydraulic Oil 46 X 5 Gallon						•	
G550P46	Oil - Hydraulic Oil 46 X 55 Gallon							•
G25P68	Oil - Hydraulic Oil 68 X 2.5 Gallon					•		
G50P68	Oil - Hydraulic Oil 68 X 5 Gallon						•	
G550P68	Oil - Hydraulic Oil 68 X 55 Gallon							•

LUBRICANTS

MINERAL BASED OILS AND GREASES

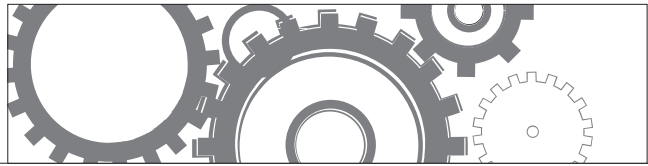

GxxP32

HYDRAULIC OIL

ISO GRADE 32



Product Code	Description	Packaging Size
G25P32	Hydraulic Oil 32	2.5 Gallon
G50P32	Hydraulic Oil 32	5 Gallon
G550P32	Hydraulic Oil 32	55 Gallon

- Premium mineral based oil with quality anti-wear additives for long life
- Good oxidation resistance, corrosion prevention, and anti-wear performance
- Recommended for use in mobile and industrial applications where either mild or severe operating conditions exist
- Ideal for general industrial equipment such as machine tools, rotary air compressors and enclosed gearboxes where extreme pressure additives are not required
- NB: **NOT** recommended for Lucas pumps with silver bearings, ammonia compressors, or as a heat transfer oil
- Always refer to the Owner's Manual for recommended oil grade and change intervals
- Approvals: Vickers M-2950-S, 1-286-S
MAG IAS P-68
DIN 51524 Part 2
US Steel 127, 127, 136
Denison HF-0, HF-1, HF-2

GxxP(46) - (68)

HYDRAULIC OIL

ISO GRADE 46 & 68



Product Code	Description	Packaging Size
G25P46	Hydraulic Oil 46	2.5 Gallon
G50P46	Hydraulic Oil 46	5 Gallon
G550P46	Hydraulic Oil 46	55 Gallon
G25P68	Hydraulic Oil 68	2.5 Gallon
G50P68	Hydraulic Oil 68	5 Gallon
G550P68	Hydraulic Oil 68	55 Gallon

- Premium mineral based oil with quality anti-wear additives for long life
- Good oxidation resistance, corrosion prevention, and anti-wear performance
- Recommended for use in mobile and industrial applications where either mild or severe operating conditions exist
- Ideal for general industrial equipment such as machine tools, rotary air compressors and enclosed gearboxes where extreme pressure additives are not required
- NB: **NOT** recommended for Lucas pumps with silver bearings, ammonia compressors, or as a heat transfer oil
- Always refer to the Owner's Manual for recommended oil grade and change intervals
- Approvals: Vickers M-2950-S, 1-286-S
MAG IAS P-70 (ISO AW-46)
MAG IAS P-69 (ISO AW-68)
DIN 51524 Part 2
US Steel 127, 127, 136
Denison HF-0, HF-1, HF-2



LUBRICANTS

MINERAL BASED OILS AND GREASES

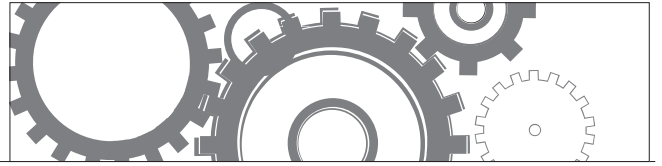

G10VATF

AUTO TRANSMISSION FLUID



Product Code	Description	Container Size
G10VATF	Auto Transmission Fluid DEX/MER	1 Gallon

- Can be used in all vehicles requiring type II or III specification fluid
- Suitable for all GM® vehicles up to 1981 to 2006
- Can be used for in service fills on most popular vehicles
- Approvals: GM® 6137M
Ford® M2C 138-CJ
Allison® C-4
Caterpillar® TO-2
DB 236.7

LUBRICANTS

MINERAL BASED OILS AND GREASES

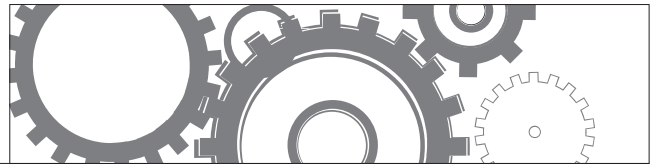

VP14G2

ALL PURPOSE GREASE

PALLADIUM COMPLEX WITH 3% MoS₂



Product Code	Description	Cartridge Size
VP14G2	MoS ₂ Fortified Lithium Complex	14oz - 400g

- Special long life grease for high load service conditions
- Fortified with extreme pressure additives
- Contains rust and corrosion inhibitors
- Tackiness adhesive additives prevent squeeze out under high loads
- Molybdenum Disulphide (MoS₂, 3%) incorporated to increase film strength
- Suited to all types of automotive, industrial and marine applications
- Meets NLGI No. 2 performance
- Grey / black in color
- 5% MoS₂ version available upon request
- 12 Units per carton

VC14G2

EXTREME PRESSURE GREASE

NLGI NO. 2 LITHIUM COMPLEX GREASE



Product Code	Description	Cartridge Size
VC14G2	Valplex EP Grease	14oz - 400g

- Contains a non-lead extreme pressure (EP) additive
 - Contains rust and corrosion inhibitors
 - Suited to extended lubrication intervals of vehicle chassis points
 - Other applications:
 - Wheel bearings (drum or disc brake equipped) for all types of vehicles and equipment
 - Oscillating bucket pins and universal joints
 - Ball, roller and slow speed plain bearings under all service conditions
 - Meets NLGI No. 2 performance
 - Blue in color
 - Smooth and tacky texture
 - 10 Units per carton
- CAUTION: DO NOT mix greases. Always thoroughly wash out bearings and housings before repacking

LUBE EQUIPMENT

GREASE, OIL, FUEL, WATER & AIR

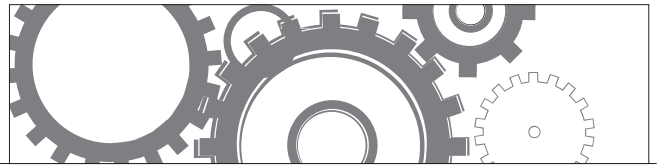

Description :

PIRTEK's extensive range of fuel, lubricant, and solvent drum pumps facilitate quick and easy fluid transfer.

If you are aiming to source a cost effective means of transferring fluids out of drums, PIRTEK will have the equipment to suit your needs to get the job done quickly.

Product Range:

- 5 Gallon drum pumps
- 15 Gallon drum pumps
- 55 Gallon drum pumps
- Hand operated drum pumps
- Manual drum pumps
- Synthetic or mineral based lubricant transfer drum pumps
- Transmission and brake fluid transfer drum pumps
- Bulk tank pumps

Applications:

- Ideal for automotive, agriculture, mining, timber, food & beverage and other primary industries
- Suit contractors and construction engineers
- Use in workshops, car dealerships, foundries etc

Description :

The extensive range of PIRTEK Greasing equipment facilitates the quick and efficient lubrication of plant and machinery, be it with the aid of simple grease nipples and grease guns or a multi-zoned, fully monitored lube system.

The new industry benchmark Series PLUS Series grease guns guarantee quick and easy greasing.

Strong technical back-up by our network will ensure that your lubrication problems are quickly and professionally solved.

Product Range:

- Grease nipples and grease nipple assortment kits
- Grease nipple extensions
- 14oz - 400g grease guns
- Grease gun accessories
- Grease swivels
- Grease hose reels
- Remote mount and manual grease kits

Applications:

- Industry application includes industrial, automotive, agricultural, transport, mining, marine, petrochemical, construction, food processing, steel and aluminum plants, forestry, milk and dairy, aviation and much more.
- * Please note when using grease gun couplers & grease gun hoses, the grease gun working pressure is rated to the lowest of the component's working pressure.

LUBE EQUIPMENT

GREASE GUNS

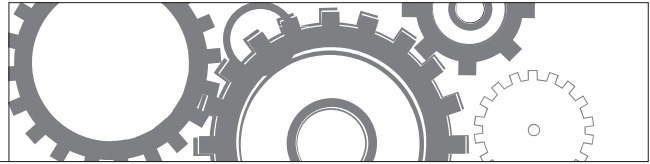

PLUS-100

STANDARD GREASE GUN

LEVER ACTION



Product Code	Description	Grease Capacity
PLUS-100	Standard Lever Action Grease Gun	14oz - 400g

- Capacity : 400 gm / 14 oz
- Grease cartridge / suction fill.
- Construction : Sheet metal Grease Gun head fitted with Bulk Loader.
- 150 mm steel extrn. & standard 4 Jaw coupler
- Develops 6,000 PSI.
- Threaded : 1/8" NPT
- Finish : Powder Coated Blue
- 1 gram/stroke

PLUS-101

HEAVY DUTY GREASE GUN

LEVER ACTION



Product Code	Description	Grease Capacity
PLUS-101	Heavy Duty Lever Action Grease Gun	14oz - 400g

- Capacity : 400 gm / 14 oz
- Grease cartridge / Suction fill / Bulk Fill.
- Construction : Aluminum Die Cast Grease Gun head fitted with bulk loader & auto air bleeder
- Features : Built-In Variable Stroke, super strong lever handle with rubber grip
- 150 mm steel extension & professional 4 Jaw coupler
- Develops 10,000 PSI
- Threaded : 1/8" NPT
- Finish : Powder Coated Blue
- 1 gram/stroke

PLUS-111

PISTOL GRIP ACTION HEAVY DUTY

GREASE GUN



Product Code	Description	Grease Capacity
PLUS-111	Pistol Grip Grease Gun	14oz - 400g

- Capacity : 400 gm / 14 oz
- Grease cartridge / suction fill, bulk loader valve fitted to head
- Construction : Aluminum Die Cast Grease Gun head fitted with automatic air bleeder.
- 300 mm Hose & professional 4 Jaw coupler.
- Develops 5000 PSI.
- Threaded : 1/8" NPT
- Finish : Powder Coated Blue
- 0.50 gram/stroke, variable stroke



LUBE EQUIPMENT

GREASE GUNS

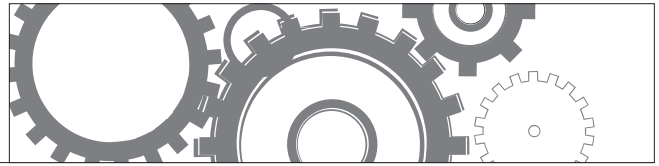

PLUS-113

HEAVY DUTY GREASE GUN WITH VARIABLE OUTPUT PISTOL GRIP ACTION



Product Code	Description	Grease Capacity
PLUS-113	Pistol Grip Grease Gun (Variable)	14oz - 400g

- Pistol Grip Grease Gun, one hand operation
- Capacity : 400 gm / 14 oz or 650 c/cm bulk fill
- Grease cartridge / suction fill / bulk fill
- Construction : Aluminum Die Cast Grease Gun head fitted with bulk loader valve.
- Features : Variable handle setting for High Pressure / high volume applications
- 300 mm High Pressure Hose & professional 4 Jaw coupler.
- Develops 7000 psi in High pressure setting & dispenses twice the amount of Grease compared to most other guns in high volume setting.
- Threaded : 1/8" NPT
- Finish : Powder Coated Blue
- 0.90 gram/stroke

PLUS-115

MINI GREASE GUN PISTOL GRIP ACTION



Product Code	Description	Grease Capacity
PLUS-115	Mini Pistol Grease Gun with dual discharge ports (inline & 90 deg)	3oz - 85g

- Capacity : 3oz - 85 gram
- Grease cartridge / suction fill
- Construction : Aluminum Die Cast Grease Gun head fitted with steel block nut
- 100 mm steel extn. & standard 4 jaw coupler
- Develops 3500 PSI
- Threaded : 1/8" NPT
- Finish : Powder Coated Blue
- 0.40 gram/stroke

PLUS-120

AIR OPERATED HEAVY DUTY GREASE GUN CONTINUOUS ACTION



Product Code	Description	Grease Capacity
PLUS-120	Continuous Action Air Operated Grease gun	14oz - 400g

- Capacity : 400 gm / 14 oz cartridge or 650 c/cm bulk fill
- Grease cartridge / suction fill / Bulk Fill
- Construction : Aluminum Die Cast Grease Gun head fitted with bulk loader valve
- 150 mm steel extn. & professional 4 jaw coupler without ball check
- Develops 4800 PSI
- Threaded : 1/8" NPT
- Finish : Powder Coated Blue
- Air inlet: 1/4" NPT
- Pressure ratio 40:1
- 0.90 gram/shot
- Delivers 14oz - 400gs/minute
- Max air inlet pressure 40-120 psi (3-8 bar)

This page is part of a complete catalog containing technical and safety data.
All data must be reviewed when selecting a product.
PIRTEK reserves the right to change technical specifications without notice.

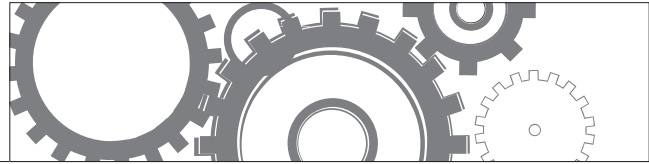

PLUS-140
PROFESSIONAL GREASE GUN
COUPLER 4 JAW



Product Code	Description	Pressure Rating
PLUS-140	Professional Grease Gun Coupler	6,000 psi

- Professional 4 Jaw Coupler with Ball Check
- 6000 psi / 415 Bar
- For Hand Operated Grease Guns
- 15mm diameter
- 1/8" NPT

PLUS-141
HEAVY DUTY GREASE GUN
COUPLER 4 JAW



Product Code	Description	Pressure Rating
PLUS-141	Heavy Duty 4 Jaw Coupler	10,000 psi

- Heavy Duty 4 Jaw Coupler with Ball Check
- 10,000 psi / 690 Bar
- For Hand & Air Operated Grease Guns
- 17mm diameter
- 1/8" NPT

PLUS-142
GREASE GUN COUPLER
90 DEGREE



Product Code	Description	Pressure Rating
PLUS-142	90 Degree Coupler without Ball Check	1,000 psi

- Hydraulic Coupler 90 Degree without Ball Check
- 1,000 psi / 69 Bar
- For hand operated Grease Guns
- 1/8" NPT

LUBE EQUIPMENT

GREASE GUN ACCESSORIES

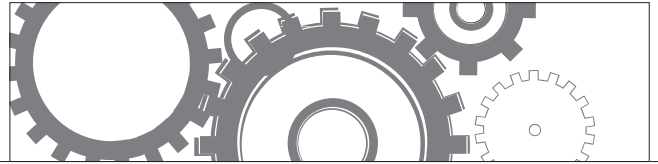

PLUS-143

HYDRAULIC COUPLER

360° SWIVEL



Product Code	Description	Pressure Rating
PLUS-143	Hydraulic Coupler 360 Deg Swivel	7,000 psi

- Hydraulic Coupler 360 deg, locks at any 45 deg position
- 3 Jaw with Ball Check
- 7,000 psi/483 bar
- For hand operated Grease Guns
- 1/8" NPT

PLUS-146

GREASE ACCESSORY KIT

QUICK CONNECT 7 PIECE



Product Code	Description	No. of Pieces
PLUS-146	Quick Connect Grease Gun Accessory Kit	7

7 pc Quick Connect Grease Guns accessory Kit Including:

- Professional Recessed Lube Adapter
- Grease Injector Needle s/s 38 mm long
- Professional 90 deg Angle Lube Adapter
- Professional Narrow Needle Nose Adapter
- Jaw Type Coupler to Seal Off Dispenser
- Regular Coupler to Right Angled Coupler
- Quick Connect Hose

LUBE EQUIPMENT

GREASE GUN ACCESSORIES

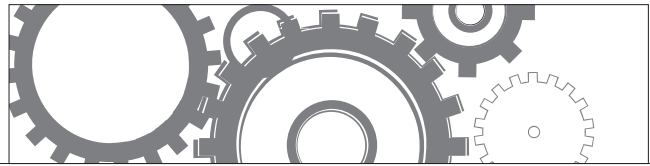

PLUS-148 - PLUS-149

GREASE DISPENSOR NOZZLE NARROW & STANDARD

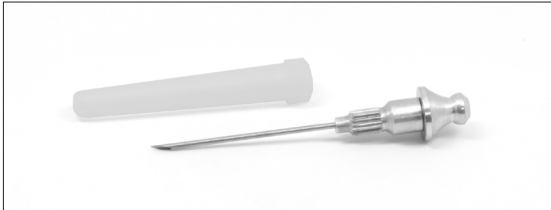

Product Code	Description	Pressure Rating
PLUS-148	1.1/2" (38mm) Long Narrow Needle (1/8" threaded NPTF)	3,500 psi
PLUS-149	1.1/2" (38mm) Grease Injector Needle	3,500 psi

- Used for injecting grease into sealed bearings
- Plus-148 threads are 1/8" NPT
- Stainless

PLUS-151 - PLUS-154

GREASE GUN HOSES STANDARD & HIGH PRESSURE



Product Code	Standard Pressure (Hand Operated Guns) 3,500 psi / 240 Bar WP (11,600 psi BP)		High Pressure (Hand and Air Operated Guns) 5,800 psi / 400 Bar WP (13,775 psi BP)	
	Length in		Length in	
	12	18	12	18
PLUS-151	•			
PLUS-152		•		
PLUS-153			•	
PLUS-154				•

- High Pressure hoses are ideal for cold weather use
- All threads are 1/8" NPT
- Standard Pressure Hose (OD = 8.5 mm, ID = 3.6 mm)
- High Pressure Hose (OD = 10.8 mm, ID = 4.1 mm)

LUBE EQUIPMENT

GREASE FITTINGS

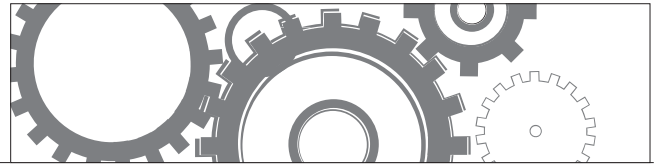

PL810 - PL832

GREASE NIPPLES



Product Code	UNF			NPT				Metric	Drive Fitting
	Str.	45°	90°	Str.	45°	65°	90°	Str.	Str.
PLUS-810 *	1/4"-28	-	-	-	-	-	-	-	-
PLUS-811 †	-	1/4"-28	-	-	-	-	-	-	-
PLUS-812 †	-	-	1/4"-28	-	-	-	-	-	-
PLUS-813 †	-	-	-	1/8"-27	-	-	-	-	-
PLUS-814 †	-	-	-	-	1/8"-27	-	-	-	-
PLUS-816 †	-	-	-	-	-	-	1/8"-27	-	-
PLUS-817 *	-	-	-	1/4"-18	-	-	-	-	-
PLUS-818 †	-	-	-	-	-	1/4"-18	-	-	-
PLUS-819 *	-	-	-	-	-	-	-	M6X1.0	-
PLUS-820 *	-	-	-	-	-	-	-	M8X1.0	-
PLUS-830 *	-	-	-	-	-	-	-	-	3/16"
PLUS-831 *	-	-	-	-	-	-	-	-	1/4"
PLUS-832 *	-	-	-	-	-	-	-	-	5/16"

† Denotes pack a quantity of 5 * Denotes pack a quantity of 10

- Head profile as per SAE J534 and DIN 71412 for Metric Fittings
- Heat treated Grease End & spring on ball check types
- Zinc plating exceeds ASTM B117
- Super strong rolled threads
- Salt Spray Tested
- Tested for operating, opening and back pressure

PLUS-182 - PLUS-184

GREASE NIPPLE ASSORTMENT - KITS

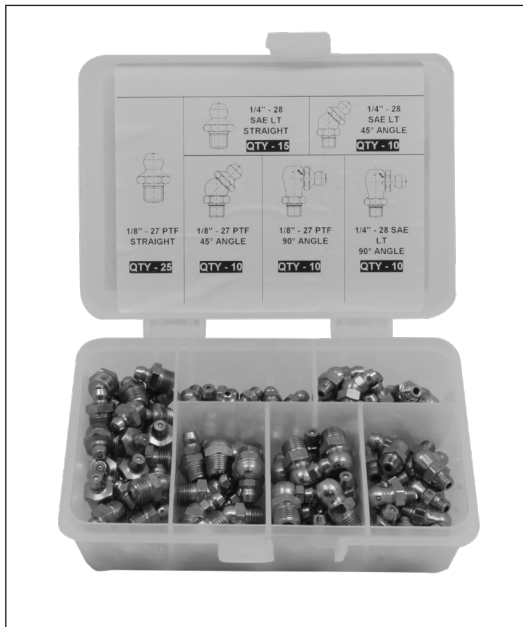

Product Code	Description	No. of Pieces
PLUS-182	Metric Assortment	80
PLUS-184	SAE / NPT Assortment	80

Description	Quantity
M6x1 Straight	20
M6x1 90°	10
M8x1 Straight	15
M8x1 90°	10
M10x1 Straight	15
M10x1 90°	10

Description	Quantity
NPT 1/8"-27 Straight	25
NPT 1/8"-27 45°	10
NPT 1/8"-27 90°	10
SAE 1/4"-28 Straight	15
SAE 1/4"-28 45°	10
SAE 1/4"-28 90°	10

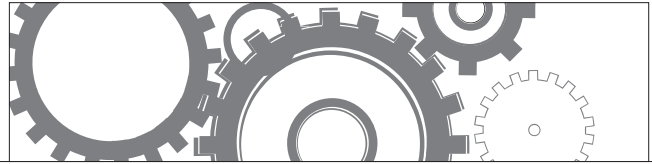

PLUS-192

GREASE FITTING UNBLOCKER



Product Code	Description	Note
PLUS-192	Grease Fitting Unblocker	Ideal for Toolbox

- Opens clogged grease fittings and loosens hardened grease joints
- Excellent for maintaining and protecting bearings, control arms, joints, king pins, etc.
- Tool has an all steel construction & is designed to be tapped with a hammer to force a light viscosity oil through the tool into the coupler & finally into the grease joint, breaking up and removing dirt and debris
- Built-In Hand Guard for added safety in use
- Flexible hose attachment reaches fittings in difficult areas
- Comes complete with grease coupler for connection onto the grease fitting and 2 spare seals for replacing the piston seals as they wear out

PLUS-193

GREASE FITTING CAPS

AVAILABLE IN 3 COLORS



Product Code	Description	Pack Size
PLUS-193R	Red Grease Fitting Cap	50
PLUS-193Y	Yellow Grease Fitting Cap	50
PLUS-193B	Black Grease Fitting Cap	50

- Plastic Caps for Grease fittings are an easy way to keep contaminants out.
- These additionally help in color coding the greasing points based on frequency of greasing or type of grease
- Designed with an inbuilt collar, these are most convenient in use & fit directly onto the greasing end of the fitting
- Made from a special plastic, these adjust to minor variations in fitting head diameter, as well as variations in temperature & practically fit all standard fittings designed for use with jaw type couplers
- Available in Black, Yellow and Red as standard with other colors that can be custom manufactured
- Sold in packs of 50

PLUS-194

GREASE FITTING THREAD TESTER

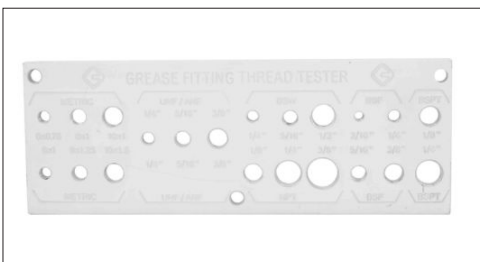

Product Code	Description	Note
PLUS-194	Grease Fitting Thread Tester	Ideal for Toolbox

- Great tool box accessory to sort out mixed fittings
- Aluminum construction with mounting holes
- Dimensions: 75mm x 207 mm
- Checks the tabulated 21 popular thread sizes

Metric	UNF	BSW	BSF	BSPT	NPT
6x0.75	1/4"	1/4"	3/16"	1/8"	1/8"
6x1.0	5/16"	5/16"	1/4"	1/4"	1/4"
8x1.0	3/8"	1/2"	5/16"	-	3/8"
8x1.25	-	-	3/8"	-	-
10x1.0	-	-	-	-	-
10x1.5	-	-	-	-	-

LUBE EQUIPMENT

OIL PUMPS

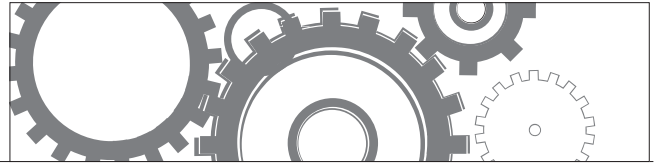

PLUS-400

STEEL TUBE LEVER ACTION DRUM PUMP TO FIT 15-55 GAL DRUMS



Product Code	Description	Delivers
PLUS-400	Lever Action Drum Pump	10 oz per stroke

- Professional Barrel pump for pumping most types of oils
- Steel Body tube with die cast aluminum adapters
- Ribbed section Aluminum Die Cast pump head for maximum strength
- Nitrile Rubber Piston rings for smooth operation
- Built-in 1-1/2" & 2" bung for use on drums with either opening
- Delivers 10 oz. (300ml) per stroke
- Comes complete with curved metal spout & telescopic suction tube for use on 15 gallon – 55 gallon drums
- Suited to oil based fluids, heating oils, motor oils, heavy and light oils, kerosene and diesel
- Not suited for water based fluids, solvents, acids, anti-freeze, or gasoline

PLUS-402

CAST IRON ROTARY DRUM PUMP TO FIT 15 TO 55 GALLON DRUMS



Product Code	Description	Delivers
PLUS-410	Rotary Drum Pump	1.3 gallons per stroke

- Professional Rotary drum pump
- Sturdy Cast Iron body with precision machined cast iron vanes for a better draw and smooth delivery
- Pump inlet, 1" NPT thread designed for volume discharge of low to medium viscosity mediums
- Dual direction operation, pumps in either direction
- Delivers 1.3 gallons per 20 turns
- Suited to oil based fluids, heating oils, motor oils, heavy and light oils, kerosene and diesel
- Not suited for water based fluids, solvents, acids, anti-freeze, or gasoline

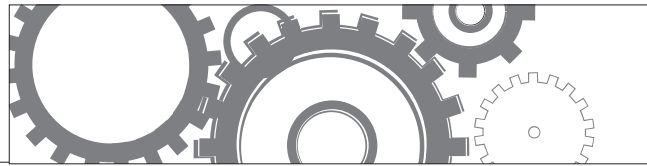

PLUS-406

LEVER ACTION BUCKET PUMP TO FIT 5 GAL BUCKETS



Product Code	Description	Delivers
PLUS-406	Lever Action Bucket Pump	Up to 2.14 oz per stroke

- Professional Barrel pump for pumping all types of oils
- Zinc plated pump body with aluminum flange and adjusting flange
- Brass piston ring fitted onto a zinc die cast piston
- Complete with 18" long pump 12" drum cover with 48"/4ft PVC hose
- Delivers 2.14 oz per stroke
- Not suited for water based fluids or other corrosive mediums

PLUS-730

AIR BLOW GUNS WITH STAINLESS STEEL NOZZLES



Product Code	Description	Materials	Inlet Port
PLUS-730	Air Blow Gun with 4-1/2" Nozzle	Body: Nylon Nozzle & Parts: S/Steel	1/4" NPTF Fem.

- Air Blow Gun with 4-1/2" & 11-3/4" nozzles
- Impact & weather resistant Nylon Body
- Stainless Steel Nozzle & parts
- Drop resistant construction
- Handle with Soft rubber grip for convenience & continuous use
- Variable speed trigger
- Ergonomic design of the gun helps eliminate the risk of Carpel Tunnel
- Connection : Brass threaded 1/4" NPT
- Operating Pressure :50 - 235 psi (3.5 - 16 BAR)
- Blowing Force at 98 psi = 0.35 Kgs
- Air Consumption: 15.18 CFM & 15.26 CFM @ 98 psi respectiely
- Noise Level : 80 db @ 100 psi

DISPENSING EQUIPMENT

HOSE REELS

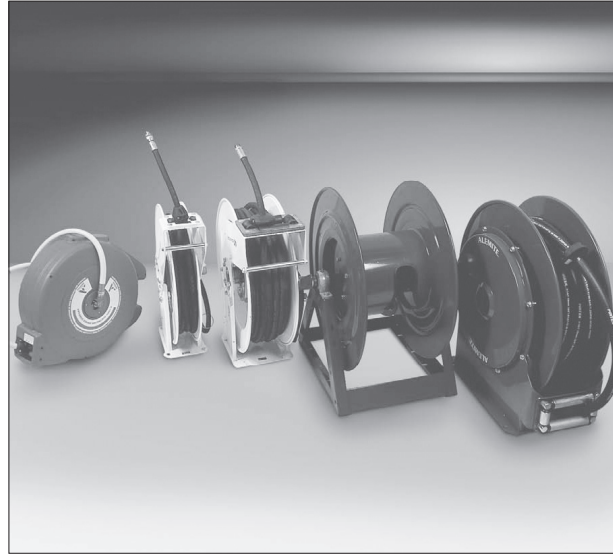
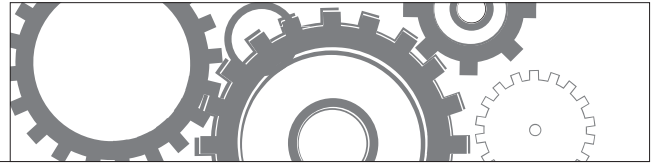

Description :

- The PIRTEK hose reel range makes light work of hose storage and retrieval. The range of hose reels facilitates the easy retrieval and storage of small or large, single or dual, short or long assemblies
- A versatile range suitable for a wide range of applications from water to fuel, lubricant, oxceyletene, breathable air and other fluids transfer
- CAD designs and stringent quality control guarantee first class quality at all times

Product Range:

- Spring rewind hose reels
- Air rewind hose reels
- Hydraulic rewind hose reels
- 12 volt and 24 volt rewind hose reels
- Manual rewind hose reels
- Suitable for hose assemblies from 1/4" ID up to 1-1/4" ID
- Suitable for hose assemblies from 20 ft long up to 738ft long

Applications:

- Primary Industry applications include timber processing, fisheries, agricultural, mining
- Secondary Industry applications include aviation, industrial, fibre packaging plants, printing plants, tyre plants, bakeries, automotive workshops, service station forecourts, contractors, steel mills, manufacturing, aluminum smelters, service trucks, golf courses etc.

DISPENSING EQUIPMENT

INDUSTRIAL HOSE REELS

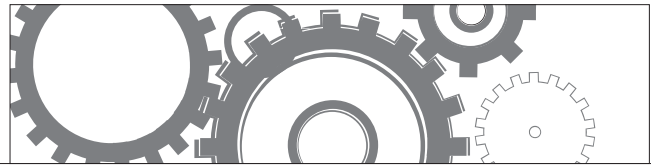

AL501xxx

OPEN TYPE BARE HOSE REELS

AIR / OIL / GREASE



Product Code	Intended Use	NPTF Threads	Recommended Hose
AL501198 †	Air / Low Pressure Water	1/2" In, 1/4" Out	40 ft Textile 3/8" 217 psi
AL501298 †	Oil	1/2" In, 1/2" Out	30 ft 1 wire 1/2" 1087 psi
AL501398 †	Grease	1/2" In, 1/4" Out	30 ft 2 wire 1/4" 5076 psi

† Available on request

- Double arm automatic rewind hose reels for air, water, oil or grease
- All metal construction with forged brass shaft for corrosion free and leak proof operation even at high pressure
- Hose recoiling is driven by a special steel spring, which provides a long life and trouble free operation
- Positionable arms for optimum operation in any mounting position: wall, ceiling, floor or tank
- Maximum hose capacity: See Table above

AL504xxx

OPEN TYPE BARE HOSE REELS

AIR / OIL / GREASE



Product Code	Intended Use	NPTF Threads	Recommended Hose
AL504199 †	Air / Low Pressure Water	1/2" In, 1/2" Out	50 ft Textile 1/2" 217 psi
AL504299 †	Oil	1/2" In, 1/2" Out	50 ft 1 wire 1/2" 1087 psi
AL504399 †	Grease	1/2" In, 1/4" Out	50 ft 2 wire 1/4" 5076 psi

† Available on request

- Dual pedestal
- Heavy duty double arm automatic rewind hose reels for air, water, oil or grease.
- All metal reinforced construction with forged brass shaft for corrosion free and leak proof operation even at high pressure.
- Hose recoiling is driven by a special steel spring, which provides a long life and trouble free operation.
- Positionable arms for an optimum operation in any mounting position: wall, ceiling, floor or tank.
- Maximum hose capacity: 50 ft x 1/2" hose

AL505xxx

3/4" HOSE CAPACITY

AIR, WATER, OR FUEL HOSE REEL



Product Code	Intended Use	NPTF Threads	Supplied Hose
AL505000 †	Air / Low Pressure Water / Oil	3/4" In, 3/4" Out	Bare Reel
AL505201 †	Air / Low Pressure Water / Fuel	3/4" In, 3/4" Out	50 ft 1 wire 3/4" 1087 psi
AL505299 †	Bare Hose Reel		Bare Reel

† Available on request

- Dual Pedestal
- Double arm, high volume, automatic rewind hose reels for air, water, or oil.
- All metal reinforced
- Full 3/4" port shaft and swivel so no flow restrictions.
- Hose recoiling is driven by a special steel spring, which provides a long life and trouble free operation.
- Positionable arms for an optimum operation in any mounting position: wall, ceiling, floor or tank.
- Maximum hose capacity: 65 ft x 1/2" hose or 50 ft x 3/4" hose.
- Models with hose include a 2 ft long inlet hose.

This page is part of a complete catalog containing technical and safety data.
All data must be reviewed when selecting a product.
PIRTEK reserves the right to change technical specifications without notice.

DISPENSING EQUIPMENT

INDUSTRIAL HOSE REELS

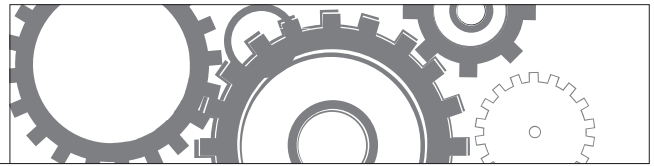

AL7342

SELF RETRACTING REEL

1" BARE HIGH CAPACITY

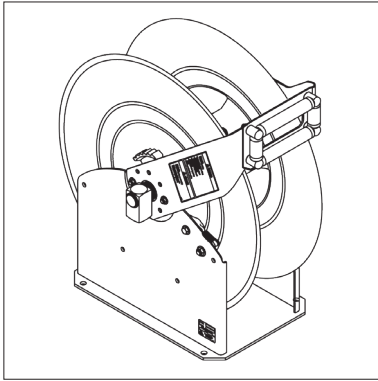

Product Code	Description	Max. Pressure	1" Hose Capacity
AL7342 †	Self Retracting Reel 1" Bare	1000 psi	50 ft 1 wire or fuel hose

- † Available on request
- High-capacity hose reel designed to deliver fuel (such as diesel fuel, aircraft fuel, and gasoline) and lubricating oils while mounted to a lubrication truck or to a ceiling* or wall)
 - The reel mounts as a single unit or in banks of as many as required
 - The hose guide arms can attach to the base assembly in five (5) different positions
 - Connections: **Inlet** 1" NPT Female **Outlet** 1" NPSM Female (or 3/4" NPT Female via supplied bushing)
 - The reel is spring-powered and self-retracting
 - When the hose is extended, the reel can be latched on either of two ratchet sections per turn of the sheave
 - A pull releases the latch from the ratchet and allows the hose to retract onto the reel
 - If used to deliver gasoline or aircraft fuel, static electricity must be prevented:
 1. delivery and connecting hose must contain a grounding wire
 2. entire fuel delivery system must be properly grounded
 - Failure to do so can result in personal injury through fire and/or explosion

* Maximum height of the base plate above the floor 16 feet to comply with warranty

ALOS615

OXY ACETYLENE HOSE

HOSE REEL



Product Code	Intended Use	Hose Capacity
ALOS615 †	OXY ACETYLENE HOSE REEL	50 ft

- † Available on request
- Heavy duty steel construction with corrosion resistant powder coat finish
 - Double 'O' Ring design prevents leakages
 - 300 psi maximum working pressure
 - Includes 50 ft of 1/4" ID delivery hose and 5 feet of lead-in hose
 - Suited to use on light commercial vehicles

DISPENSING EQUIPMENT

COMPACT HOSE REELS

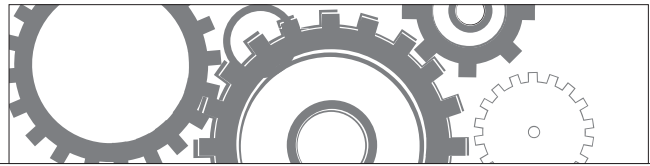

ALAP650 / ALAP840

AIR REELS

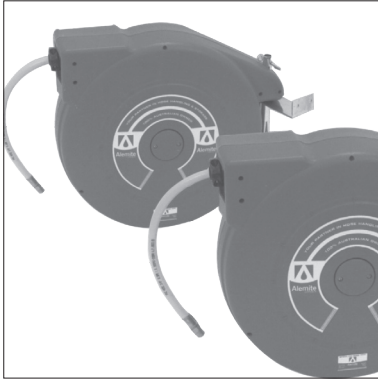

Product Code	Description	Supplied Hose
ALAP650 †	Air Reel	50 ft x 3/8" hose with 3/8" NPT M&F
ALAP840 †	Air Reel	40 ft x 1/2" hose with 1/2" NPT M&F

† Available on request

- Used extensively in locations including service station forecourts, automotive mechanical workshops, assembly plants, processing plants and food processing facilities
- Supplied inclusive of supply and lead-in hoses
- Two way roller guides extend hose life and ensure even hose retrieval and storage
- Detachable but sturdy steel mounting brackets facilitate quick and easy hose reel mounting
- Can be floor, wall or ceiling mounted
- Automatic and positive latching mechanism locks the hose assembly at the desired length

ALAP809 / ALAS812

COMPACT AIR REELS



Product Code	Description	Dimensions (mm)
ALAP809 †	Air Reel	30 ft of 5/16" ID hose
ALAS812 †	Air Reel	40 ft of 3/8" ID hose

† Available on request

- Ideal solution where space is limited
- Constant tension or automatic stop option
- Fully serviceable spring cassette
- Moulded steel electrostatically painted cover
- Reinforced polyurethane hose
- 4-way roller guide assembly
- Swivel mounting bracket
- Heavy duty inlet swivel rated to 300 psi
- Includes delivery hose and inlet hose

ALWP808 / ALWS812

COMPACT WATER REELS



Product Code	Description	Dimensions (mm)
ALWP808 †	Water Reel	30 ft of 5/16" ID hose
ALWS812 †	Water Reel	40 ft of 3/8" ID hose

† Available on request

- Ideal solution where space is limited
- Constant tension or automatic stop option
- Fully serviceable spring cassette
- Moulded steel electrostatically painted cover
- Reinforced polyurethane hose
- 4-way roller guide assembly
- Swivel mounting bracket
- Heavy duty inlet swivel rated to 300 psi
- Includes delivery hose and inlet hose

UTILITY HOSE ASSEMBLY

50FT AIR HOSE

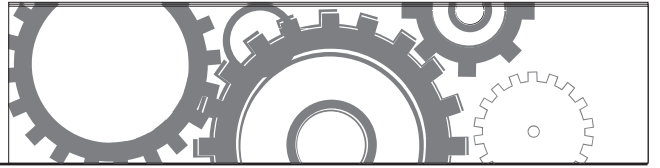

UHA-060450

BLUE, RED AND YELLOW AIR HOSE
ASSEMBLY

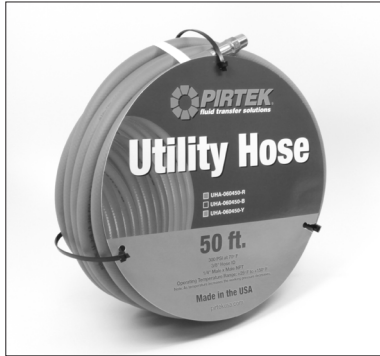

Product Code	Description	Length
UHA-060450-B	Blue 3/8" I.D Premium Reinforced PVC Air Hose Assembly	50ft
UHA-060450-R	Red 3/8" I.D Premium Reinforced PVC Air Hose Assembly	50ft
UHA-060450-Y	Yellow 3/8" I.D Premium Reinforced PVC Air Hose Assembly	50ft

- Premium reinforced PVC
- Available in Blue, Red and Yellow color
- 300 psi maximum working pressure at 70°F
- Includes 50 ft of 3/8" ID air hose with 1/4" brass male NPT fittings each end

COMP-01

JACKHAMMER HOSE
ASSEMBLY

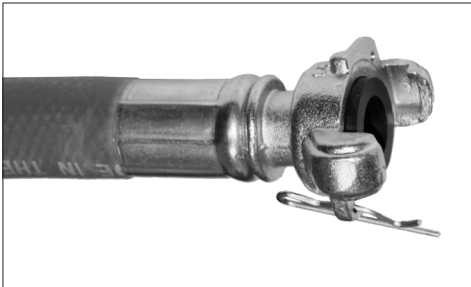

Product Code	Description	Length
COMP-01	Red 3/4" I.D Jackhammer Hose Assembly	50ft

- Durable 4 spiral polyester yarn
- 300 psi maximum working pressure at 70°F
- Temperature range -40°F to +200°F
- Includes 50 ft assembly of 3/4" ID Jackhammer hose 3/4" crimped on Chicago / Crowsfoot fitting each end

PRESSURE GAUGES

BOURDON TUBE GENERAL PURPOSE

2-1/2" DIAMETER

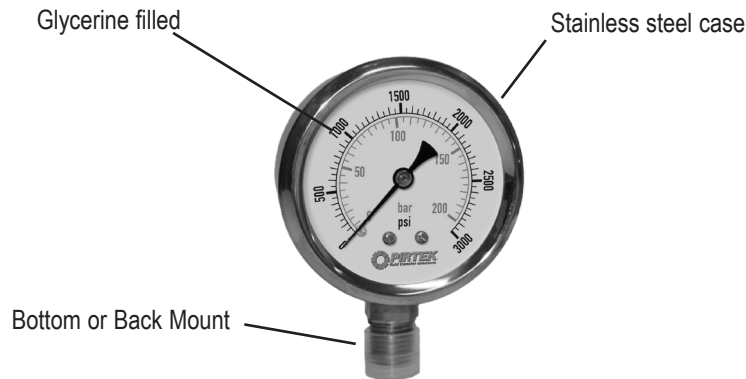

Description:

- A high quality bottom entry gauge with rugged construction and quality components
- Dual scales psi / bar (other pressure units available on request)
- Overpressure protection at the full scale value
- Pressure compensating diaphragm to reduce glycerine expansion related errors
- Temperature range:
 - 40°F to 180°F (flow media)
 - 4°F to 140°F (ambient)

Materials and Specifications:

- Stainless steel 304 case and bezel - 2-1/2" nominal diameter
- Polycarbonate lens with white plastic face and black / red lettering and pointer
- Copper - zinc alloy movement
- 99.5% glycerine filled (86.5% for pressure ratings below 36 psi)
- Phosphor Bronze Bourdon tube

Applications and Notes:

- Low internal wear due to glycerine fill
- Low weight
- Constant load: 3/4 full scale value
- Suited to a wide range of food and chemical industry applications, as well as general hydraulic equipment, pumps, compressors, and high pressure cleaners

2-1/2" BOURDON TUBE PRESSURE GAUGES			
Product Code		Dimensions mm	Range
Bottom Entry	Back Mount	Entry Thread	• see note below
PPG-030	PPBM-030	1/4"-18 Male NPT	0 - 30 psi
PPG-060	PPBM-060		0 - 60 psi
PPG-100	PPBM-100		0 - 100 psi
PPG-200	PPBM-200		0 - 200 psi
PPG-300	PPBM-300		0 - 300 psi
PPG-1000	PPBM-1000		0 - 1000 psi
PPG-1500	PPBM-1500		0 - 1500 psi
PPG-2000	PPBM-2000		0 - 2000 psi
PPG-3000	PPBM-3000		0 - 3000 psi
PPG-5000	PPBM-5000		0 - 5000 psi
PPG-6000	PPBM-6000	0 - 6000 psi	
PPG-10000	PPBM-10000	0 - 10000 psi	

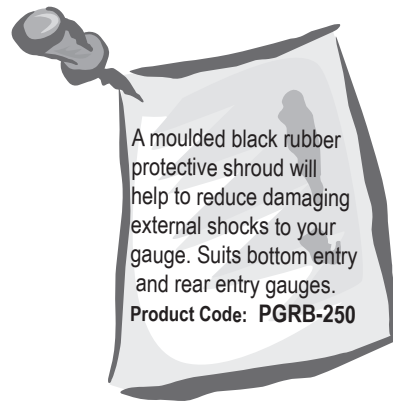

A moulded black rubber protective shroud will help to reduce damaging external shocks to your gauge. Suits bottom entry and rear entry gauges.
Product Code: PGRB-250



* Accuracy: ±1.6% FSD

- **Note:** PSI gauges are dual scale psi/bar, other scales available upon request.

PRESSURE GAUGES

BOURDON TUBE GENERAL PURPOSE

4 INCH DIAMETER

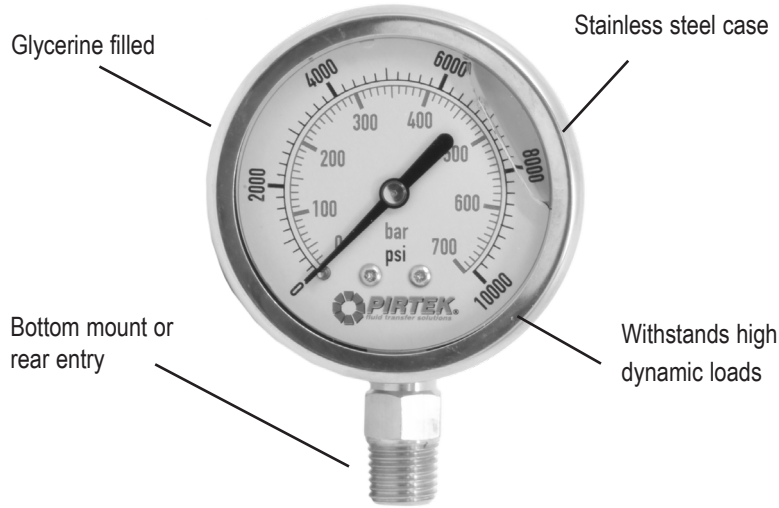

Description:

- High reliability and long service life due to modular construction system
- Capable of Dynamic Load to 90% Full Scale
- Accuracy class $\pm 1.6\%$ FSD
- Vibration free display
- Temperature range:
 - 4°F to 176°F (flow media)
 - 13°F to 150°F (ambient)
- Dual scale is psi/bar

Materials and Specifications:

- Stainless steel 304 case and bezel - 4in nominal diameter
- Polycarbonate cover with white aluminum face with black / red lettering and pointer
- Copper - zinc alloy movement
- 99.5% glycerine filled (86.5% for pressure ratings below 36 psi)
- Stainless steel 316 helical tube for pressure ranges above 5000 psi

Applications:

- Suited to a wide range of industry applications including power stations, general mechanical engineering, pumps, hydraulics, compressors, and water treatment plants

4 INCH BOURDON TUBE PRESSURE GAUGES - BOTTOM MOUNT			
Product Code		Dimensions mm	Range
Bottom Entry	Back Mount	Entry Thread	
PPG-04-160BE*	-	1/2"-14 NPT Bottom Entry	0 - 160 psi
PPG-04-300BE*	-		0 - 300 psi
PPG-04-600BE*	-		0 - 600 psi
PPG-08-1000BE*	-		0 - 1000 psi
PPG-08-2000BE*	-		0 - 2000 psi
PPG-08-3000BE*	-		0 - 3000 psi
PPG-08-5000BE*	-		0 - 5000 psi
PPG-08-6000BE*	-		0 - 6000 psi
PPG-08-10000BE*	-		0 - 10,000 psi

*Available on request.

4 INCH BOURDON TUBE PRESSURE GAUGES - BACK MOUNT			
Product Code		Dimensions mm	Range
Bottom Entry	Back Mount	Entry Thread	
-	PPG-04-160BM*	1/2"-14 NPT Rear Entry	0 - 160 psi
-	PPG-04-300BM*		0 - 300 psi
-	PPG-04-600BM*		0 - 600 psi
-	PPG-08-1000BM*		0 - 1000 psi
-	PPG-08-2000BM*		0 - 2000 psi
-	PPG-08-3000BM*		0 - 3000 psi
-	PPG-08-5000BM*		0 - 5000 psi
-	PPG-08-6000BM*		0 - 6000 psi
-	PPG-08-10000BM*		0 - 10,000 psi

*Available on request.

Note: 1/4" NPT is the standard connection for gauges 600 psi and below, 1/2" NPT is the standard for gauges 1000 psi and above.

PRESSURE GAUGES

DIGITAL 30 - 10,000 PSI SELECTABLE WITH BAR GRAPH

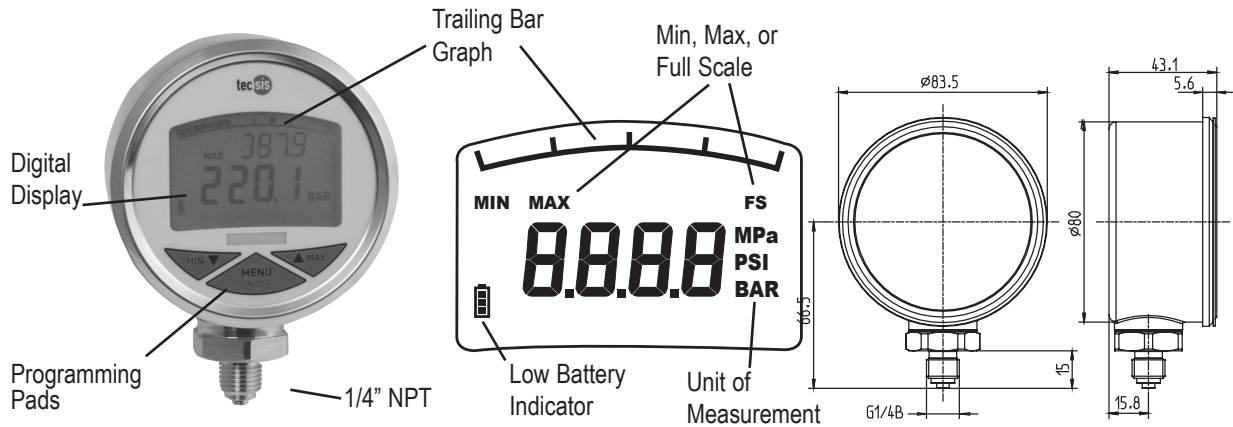

Description:

- Fine step selection of the pressure range
- Trailing pointer function on bar graph shows trend
- 1/2" high digital numbers - 4 digit
- Can be set to measure PSI, BAR, or MPa (other pressure units available on request)
- Min / Max memory
- Battery power allows independence from mains supply
- Overload limit 2-fold max. 14503 psi
- Temperature compensation range: 32°F to 140°F

Materials and Specifications:

- Stainless steel case
- Parts in contact with measured media:
 - ≤ 725 psi st. steel, alumina, NBR, ceramic measuring cell
 - ≥ 1450 psi st. steel only, thin film measuring cell
- Uses 2 AA batteries (Mignon)
- Battery life 4000 hours (2000 mAh batteries)
- Temperature ranges:
 - Storage: -4°F to +158°F
 - Measured Medium: -22°F to +185°F (to +212°F over 1450 psi)
 - Ambient: -14°F to +140°F

Applications and Notes:

- Ideal for monitoring pressure
- Suited to a wide range of machinery and hydraulic equipment
- **Accuracy *: 0.5% of full scale ± 1 digit (± 50psi 3.5 bar of the reading)**
- Conversion rate 5 per second
- Stability: ≤ ± 0.2% of full scale under reference conditions
- Humidity : < 90% non-condensing

DIGITAL PRESSURE GAUGES *			
Product Code	Measuring Range	Dimensions mm	Weight
PSI / BAR / MPa	Selectable in steps from 30 to 10,000 psi	Entry Thread	
PPDG-10000**		1/4"-18 NPT	0.4

* Please note the accuracy of this gauge when using at low pressures.

**Available on request.

PIRTEK recommend the use of a protective moulded shroud for your gauge to help reduce external shocks to the gauge.
Product Code **PDRB-325**



TEST POINTS

TEST 20 SERIES

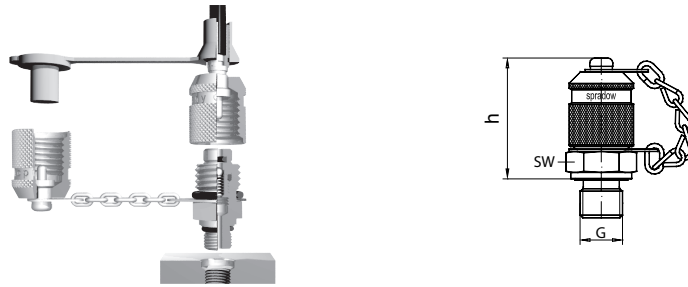

Description:

- PIRTEK Test 20 couplings are used for the monitoring and control of pressure as well as to enable system ventilation
- The system allows connection to a hydraulic system even when at full pressure
- It facilitates the switching of devices

Materials and Specifications:

- NBR Seals (Viton to order)
- Temperature range -4°F to +212°F
- Surface Treatment Hexavalent Chromium (CrVi) free. Stainless steel also available †
- Max. Work Pressure 9137 psi at 3:1 Safety Factor
- Supplied complete with M16 x 2 steel cap

Applications and Notes:

- The couplings are intended specifically for use with mineral oil based hydraulic oils
- The connection is leakproof and incorporates a metal dust protection cap that resists vibration
- A limited number of couplings with M12 x 1.5 threads are also available

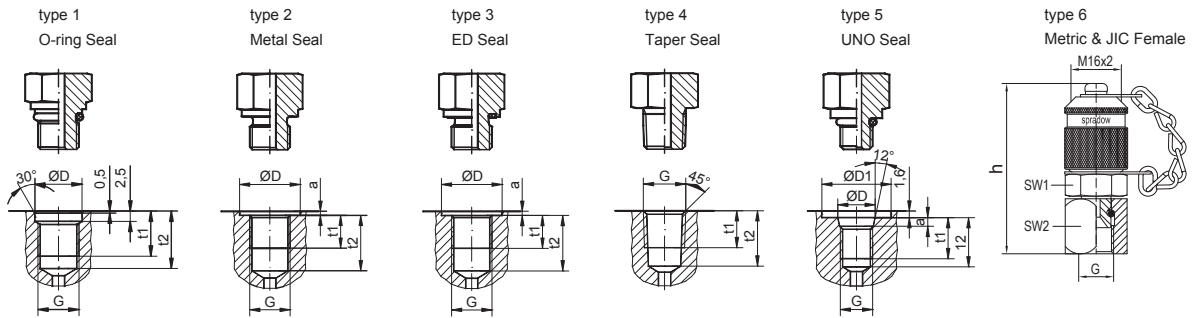

Product Code (M16 x 2 threads)		Thread G	SW1	SW2	h	Seal Arrangement	ØD	ØD1	a	t1	t2
NBR Seals	Viton Seals										
MTP162-02BP*	MTP162-02BPV*	1/8"-28 BSPP ED	17		39	3	15			8	10.5
MTP162-02BT*	MTP162-02BTV*	1/8"-28 BSPT	17		35	4				5.5	9.5
MTP162-02NPT*	MTP162-02NPTV*	1/8"-27 NPT	17		36	4				6.9	11.6
MTP162-04BP*	MTP162-04BPV*	1/4"-19 BSPP ED	19		37	3	20		1.5	12	15.5
MTP162-04BT*	MTP162-04BTV*	1/4"-19 BSPT	17		35	4				8.5	13.5
MTPSS162-04BT †*		1/4"-19 BSPT St. Steel	17		35	4				8.5	13.5
MTP162-04NPT*	MTP162-04NPTV*	1/4"-18 NPT	19		35	4				10	16.4
MTP162-04JIC*		7/16"-20 JIC Female	17	17	54	6					
MTP162-04UN*		7/16"-20 UN-O	17		38	5	12.4	21	2.4	11.5	14
MTP162-06JIC*		9/16"-18 JIC Female	17	19	57	6					
MTP162-12JIC*		3/4"-16 JIC Female	22	22	56	6					
MTP162-10JIC*		7/8"-14 JIC Female	27	27	61	6					
MTP162-06UN*		9/16"-18 UN-O	19		38	5	15.7	25	2.5	12.7	15.5
MTP162-M08*		M8 x 1 O-Ring Seal	17		37	1	9.5			11	14
MTP162-M10*	MTP162-M10V*	M10 x 1 O-Ring Seal	17		37	1	11.5			11	14
MTP162-M12*	MTP162-M12V*	M12 x 1.5 ED	17		37	3	18		1.5	12	15
MTP162-M14ED*	MTP162-M14V*	M14 x 1.5 ED	19		37	3	20		1.5	12	15
MTP162-M16ED*		M16 x 1.5 ED	22		37	3	23		1.5	12	15
MTP162-10ST*		DN10 Staple Male									
MT162BH*		Test 20 Bulkhead Cplg.									
MT162HJ*		Test 20 Hose Joiner M16									
Product Code (Type 6 Metric Female)											
Light Series (L)	Heavy Series (S)	Light	Heavy		L / S	L / S					
MTP162-06LFM*	MTP162-06SFM*	M12x1.5	M14x1.5	17	14 / 17	53 / 54					6
MTP162-08LFM*	MTP162-08SFM*	M14x1.5	M16x1.5	17	17 / 19	53 / 51					6
MTP162-10LFM*	MTP162-10SFM*	M16x1.5	M18x1.5	17	19 / 22	50 / 51					6
MTP162-12LFM*	MTP162-12SFM*	M18x1.5	M20x1.5	17	22 / 24	50 / 51					6
MTP162-15LFM*	MTP162-16SFM*	M22x1.5	M24x1.5	17	27 / 30	51 / 57					6
MTP162-18LFM*	MTP162-20SFM*	M26x1.5	M30x2	17	22 / 25	59 / 62					6
Product Code (M12 x 1.5 threads)											
MTP1215-04NPT*		1/4"-18 NPT									
MTP1215-04BT*		1/4"-19 BSPT									

*Available on request.

TEST HOSES & GAUGE ADAPTERS

TEST 20 SERIES

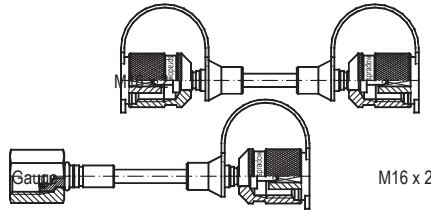

M16 x 2

M16 x 2

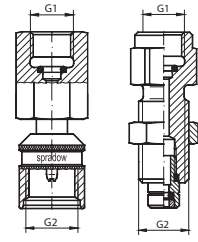

type 1

type 2

Gauge Adapters

Description:

- A range of off-the-shelf Test 20 hose and fittings combinations in various lengths
- Custom made configurations are also available
- PIRTEK Test 20 hoses and couplings are used for the monitoring and control of pressure as well as to enable system ventilation
- The system allows connection to a hydraulic system even when at full pressure
- It facilitates the switching of devices

Materials and Specifications:

- Polyamide core and cover
- ID 2 mm, OD 5 mm
- Weight: 4.87 grams per foot
- Synthetic fibre reinforcement
- Min. Bend Radius 20 mm
- Temperature Range: -31 °F to +212 °F
- Surface Treatment of fittings: Hexavalent Chromium (CrVi) free

Applications and Notes:

- Ideal for monitoring pressure
- Suited to a wide range of machinery and hydraulic equipment
- Pressure Rating: W.P. 9137 psi at 3:1 Safety Factor (Please observe Thread Form pressure limitations)

GAUGE ADAPTERS			
Product Code	Test Point	Gauge	Type
MTGAF162-04BPF*	M16 x 2 Fm	1/4" BSP Fm	1
MTGAM162-04BPF*	M16 x 2 Male	1/4" BSP Fm	2

TEST 20 HOSE ASSEMBLIES WITH M16 x 2 THREADS			
Other configurations available on request			
Product Code	End A	End B	Length
MT2162162-1000*	M16 x 2	M16 x 2	40 in
MT2162162-1500*	M16 x 2	M16 x 2	60 in
MT2162162-2000*	M16 x 2	M16 x 2	80 in
MT2162162-4000*	M16 x 2	M16 x 2	160 in
MT2162G04-1000*	M16 x 2	1/4" Gauge	40 in
MT2162G04-1500*	M16 x 2	1/4" Gauge	60 in
MT2162G04-2000*	M16 x 2	1/4" Gauge	80 in
MT2162G04-4000*	M16 x 2	1/4" Gauge	160 in

TEST HOSE ASSEMBLY COMPONENTS		
MTH-02*	DN2 Mini Test Hose	in
MTF-02*	Ferrule to suit Test Hose	ea
MTJF1-0402PT*	7/16" JIC Fm. Hose Tail	ea
MTJF1-0602PT*	9/16" JIC Fm. Hose Tail	ea
MTBF1G-0402PT*	1/4" Pressure Gauge Fm. Hose Tail	ea
MTBF1G-0802PT*	1/2" Pressure Gauge Fm. Hose Tail	ea
MTBPM1-0202PT*	1/8" BSPP Male Hose Tail	ea
MTBPM1-0402PT*	1/4" BSPP Male Hose Tail	ea
MTBF1-0402PT*	1/4" BSPP Female Hose Tail	ea
MTNM1-0202PT*	1/8" NPT Male Hose Tail	ea
MTNM1-0402PT*	1/4" NPT Male Hose Tail	ea
MTF1-1215PT*	M12 x 1.5 Female Hose Tail	ea
MTF1-1615PT*	M16 x 1.5 Female Hose Tail	ea
MTF1-1620PT*	M16 x 2 Female Hose Tail	ea
MTF1-0202PT*	Plug In Hose Tail	ea
MTSMP1-0602*	6 mm Metric Standpipe Str. Hose Tail	ea
MTSMP9-0602*	6 mm Metric Standpipe 90° Hose Tail	ea
MT162-HOSE CAP/PLUG*	Plug In Cap for Test Hose	ea

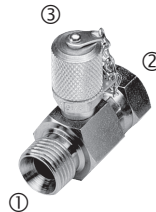

BSP In-Line Test Point Adapter

Product Code	BSPT Male	BSPP Female	Test Connection
	①	②	③
MFBB-04-04-02*	1/4" - 19	1/4" - 19	M16x2 Test 20
MFBB-06-06-02*	3/8" - 19	3/8" - 19	M16x2 Test 20
MFBB-08-08-02*	1/2" - 14	1/2" - 14	M16x2 Test 20
MFBB-12-12-02*	3/4" - 14	3/4" - 14	M16x2 Test 20

Note:- that the Test Point is installed via a 1/8" BSPT port & is ordered separately
*Available on request.

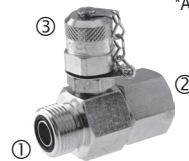

ORFS In-Line Test Point Adapter

Product Code	ORFS Male	ORFS Female	Test Connection
	①	②	③
MFBB-04-04-02*	9/16" - 18	9/16" - 18	M16x2 Test 20
MFBB-06-06-02*	11/16" - 16	11/16" - 16	M16x2 Test 20
MFBB-08-08-02*	13/16" - 16	13/16" - 16	M16x2 Test 20
MFBB-10-10-02*	1" - 14	1" - 14	M16x2 Test 20

Note:- that the Test Point is installed via a 1/8" BSPT port & is ordered separately
*Available on request.

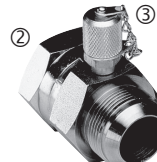
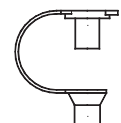
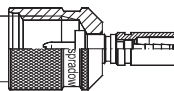
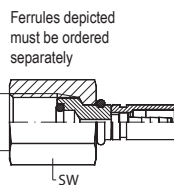

MFJB

JIC In-Line Test Point Adapter

Product Code	JIC Male	JIC Female	Test Connection
	①	②	③
MFJB-04-04-02*	7/16" - 20	7/16" - 20	M16x2 Test 20
MFJB-06-06-02*	9/16" - 18	9/16" - 18	M16x2 Test 20
MFJB-08-08-02*	3/4" - 16	3/4" - 16	M16x2 Test 20
MFJB-10-10-02*	7/8" - 14	7/8" - 14	M16x2 Test 20
MFJB-12-12-02*	1.1/16" - 12	1.1/16" - 12	M16x2 Test 20
MFJB-16-16-02*	1.5/16" - 12	1.5/16" - 12	M16x2 Test 20

Note:- that the Test Point is installed via a 1/8" BSPT port & is ordered separately
*Available on request.

AUTOMOTIVE HOSES

Tools



92504

HAND CUTTING TOOL

HAND CUTTER FOR AIR CONDITIONING HOSES, THERMOPLASTIC AND NYLON



Product Code	Description
92054	Hand Cutter for Hose and Tube - New Style
92056	Replacement Blade for Hand Cutter 92054

- A robustly made hand cutting tool for cleanly cutting a wide range of hose and tube products
- Replaceable blade

AIR CONDITIONING PRODUCTS

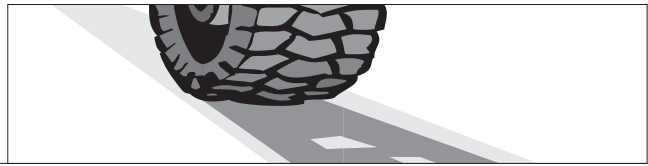

AC5 AUTO AIR CONDITIONING HOSE

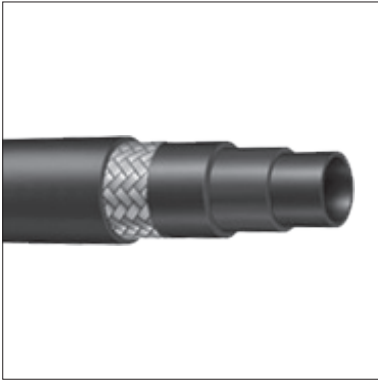

Product Code	Dimensions		Outside Diameter	Min. Bend Radius	Pressure PSI		Weight	
	Dash Size	Nominal Dia.			Working	Min. Burst		
		mm	ins	mm			mm	
100AC5-06	6	8	5/16	19.1	16	500	2000	0.20
100AC5-08	8	10	13/32	23.0	25	500	2000	0.28
100AC5-10	10	12	1/2	25.4	32	500	2000	0.33
100AC5-12	12	16	5/8	28.6	50	350	1750	0.38

Specifications

- Chloroprene blend tube compound
- Extruded polyamide barrier for low permeation
- Two spirals of reinforced polyester
- Black Chloroprene cover (CIIR)
- Temperature Range of -40°F to +257°F
- Meets SAE J2064 Type C Class 11

Features

- Light weight and flexible for easy routing
- Compatible with R134a and many other vehicular refrigerants
- Compatible with PAG (Polyalkylene glycol) oil and other popular lubricants

ACF FERRULES TO SUIT AIR CONDITIONING HOSE



Product Code	Description
ACF-06	Steel ferrule to suit 5/16" 100AC5 Air Con hose
ACF-08	Steel ferrule to suit 13/32" 100AC5 Air Con hose
ACF-10	Steel ferrule to suit 1/2" 100AC5 Air Con hose
ACF-12	Steel ferrule to suit 5/8" 100AC5 Air Con hose

AC1596 ONE PIECE WELD ON HOSE TAILS

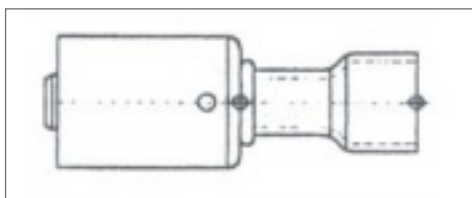

Product Code	Tube Size (ins)	Hose Tail Size	
Steel Tails			
AC1596-06	3/8"	-06	5/16"
AC1596-08	1/2"	-08	13/32"
AC1596-10	5/8"	-10	1/2"
AC1596-12	3/4"	-12	5/8"

AIR CONDITIONING PRODUCTS



ACR

AUTO AIR CONDITIONING O-RINGS

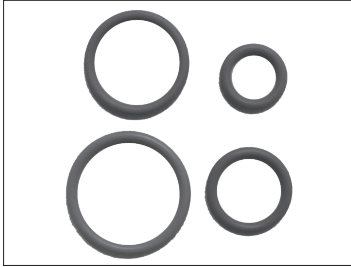

Product Code	Description
ACR-06	Air Con O-ring HNBR Green suits -06 (3/8") size
ACR-8	Air Con O-ring HNBR Green suits -08 (1/2") size
ACR-10	Air Con O-ring HNBR Green suits -10 (5/8") size
ACR-12	Air Con O-ring HNBR Green suits -12 (3/4") size

Specifications

- HNBR (Hydrogenated Nitrile Butadiene Rubber)
- good physical strength and retention properties after long term exposure to oil, heat & chemicals.

Features

- HNBR Green O-rings are used in valves / ports of air conditioning components and hose assemblies.

AC-130x

STRAIGHT ONE PIECE FITTING FEMALE PILOT O-RING

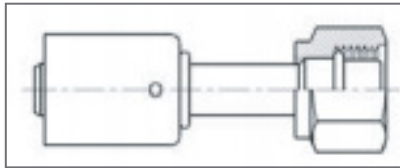

Product Code	Description	Thread
AC-1301	-06 Tail Female Pilot O-Ring -06	5/8" - 18
AC-1302	-08 Tail Female Pilot O-Ring -08	3/4" - 18
AC-1303	-10 Tail Female Pilot O-Ring -10	7/8" - 18
AC-1304	-12 Tail Female Pilot O-Ring -12	1.1/16" - 16
AC-1305	-08 Tail Female Pilot O-Ring -06	5/8" - 18
AC-1306	-10 Tail Female Pilot O-Ring -08	3/4" - 18
AC-1307	-12 Tail Female Pilot O-Ring -10	7/8" - 18
AC-1308	-06 Tail Female Pilot O-Ring -08	3/4" - 18
AC-1310	-10 Tail Female Pilot O-Ring -12	1.1/16" - 16

AC-130x-R

STRAIGHT ONE PIECE FITTING FEMALE PILOT O-RING WITH SERVICE PORT

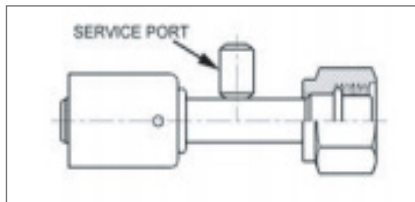

Product Code	Description	Thread	Service Port
AC-1301-R12	-06 Tail Female Pilot O-Ring -06 with R12 Service Port	5/8" - 18	1/4"
AC-1302-R12	-08 Tail Female Pilot O-Ring -08 with R12 Service Port	3/4" - 18	1/4"
AC-1303-R12	-10 Tail Female Pilot O-Ring -10 with R12 Service Port	7/8" - 18	1/4"
AC-1301-R134	-06 Tail Female Pilot O-Ring -06 with R134 Service Port	5/8" - 18	16mm
AC-1302-R134	-08 Tail Female Pilot O-Ring -08 with R134 Service Port	3/4" - 18	16mm
AC-1303-R134	-10 Tail Female Pilot O-Ring -10 with R134 Service Port	7/8" - 18	13mm
AC-1304-R134	-12 Tail Female Pilot O-Ring -12 with R134 Service Port	1.1/16" - 16	13mm

AIR CONDITIONING PRODUCTS



AC-131x STRAIGHT ONE PIECE FITTING 45° FEMALE PILOT O-RING

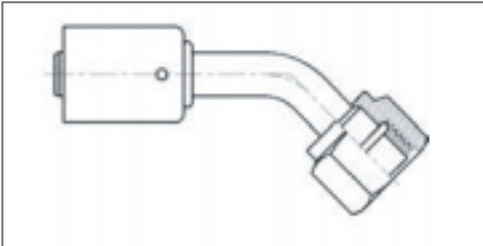

Product Code	Description	Thread
AC-1311	-06 Tail 45° Female Pilot O-Ring -06	5/8" - 18
AC-1312	-08 Tail 45° Female Pilot O-Ring -08	3/4" - 18
AC-1313	-10 Tail 45° Female Pilot O-Ring -10	7/8" - 18
AC-1314	-12 Tail 45° Female Pilot O-Ring -12	1.1/16" - 16
AC-1315	-08 Tail 45° Female Pilot O-Ring -06	5/8" - 18
AC-1316	-10 Tail 45° Female Pilot O-Ring -08	3/4" - 18
AC-1317	-12 Tail 45° Female Pilot O-Ring -10	7/8" - 18

AC-132x-R STRAIGHT ONE PIECE FITTING 90° FEMALE PILOT O-RING

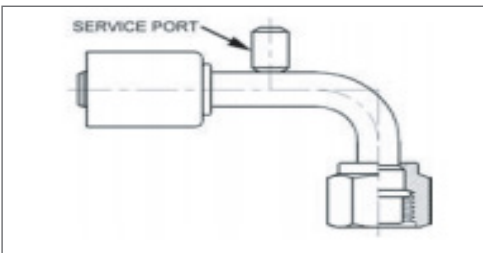

Product Code	Description	Thread	Service Port
AC-1321-R12	-06 Tail 90° Female Pilot O-Ring -06 with R12 Service Port	5/8" - 18	1/4"
AC-1322-R12	-08 Tail 90° Female Pilot O-Ring -08 with R12 Service Port	3/4" - 18	1/4"
AC-1323-R12	-10 Tail 90° Female Pilot O-Ring -10 with R12 Service Port	7/8" - 18	1/4"
AC-1321-R134	-06 Tail 90° Female Pilot O-Ring -06 with R134 Service Port	5/8" - 18	16mm
AC-1322-R134	-08 Tail 90° Female Pilot O-Ring -08 with R134 Service Port	3/4" - 18	16mm
AC-1323-R134	-10 Tail 90° Female Pilot O-Ring -10 with R134 Service Port	7/8" - 18	13mm
AC-1324-R134	-12 Tail 90° Female Pilot O-Ring -12 with R134 Service Port	1.1/16" - 16	13mm

AC-132x STRAIGHT ONE PIECE FITTING 90° FEMALE PILOT O-RING WITH SERVICE PORT

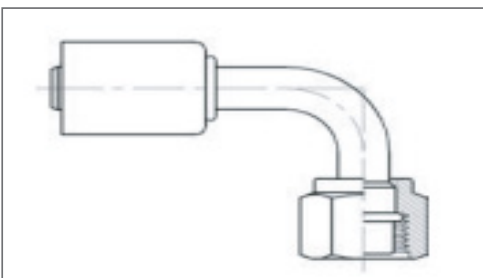

Product Code	Description	Thread
AC-1321	-06 Tail 90° Female Pilot O-Ring -06	5/8" - 18
AC-1322	-08 Tail 90° Female Pilot O-Ring -08	3/4" - 18
AC-1323	-10 Tail 90° Female Pilot O-Ring -10	7/8" - 18
AC-1324	-12 Tail 90° Female Pilot O-Ring -12	1.1/16" - 16
AC-1325	-08 Tail 90° Female Pilot O-Ring -06	5/8" - 18
AC-1326	-10 Tail 90° Female Pilot O-Ring -08	3/4" - 18
AC-1327	-12 Tail 90° Female Pilot O-Ring -10	7/8" - 18
AC-1328	-06 Tail 90° Female Pilot O-Ring -08	3/4" - 18
AC-1330	-10 Tail 90° Female Pilot O-Ring -12	1.1/16" - 16

AIR CONDITIONING PRODUCTS



AC-140x STRAIGHT ONE PIECE FITTING MALE PILOT O-RING

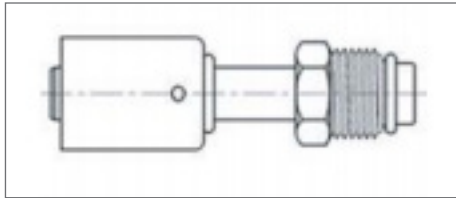

Product Code	Description	Thread
AC-1401	-06 Tail Male Pilot O-Ring -06	5/8" - 18
AC-1402	-08 Tail Male Pilot O-Ring -08	3/4" - 18
AC-1403	-10 Tail Male Pilot O-Ring -10	7/8" - 18
AC-1404	-12 Tail Male Pilot O-Ring -12	1.1/16" - 16
AC-1405	-08 Tail Male Pilot O-Ring -06	5/8" - 18
AC-1406	-10 Tail Male Pilot O-Ring -08	3/4" - 18
AC-1407	-12 Tail Male Pilot O-Ring -10	7/8" - 18
AC-1408	-06 Tail Male Pilot O-Ring -08	3/4" - 18

AC-140x-R STRAIGHT ONE PIECE FITTING MALE PILOT O-RING WITH SERVICE PORT

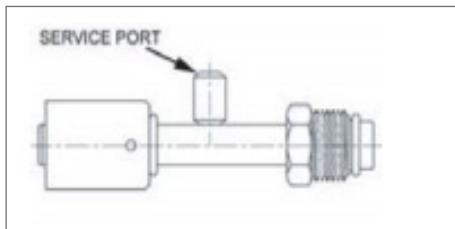

Product Code	Description	Thread	Service Port
AC-1401-R134	-06 Tail Male Pilot O-Ring -06 With a R134 Service Port	5/8" - 18	16mm
AC-1402-R134	-08 Tail Male Pilot O-Ring -08 With a R134 Service Port	3/4" - 18	16mm
AC-1403-R134	-10 Tail Male Pilot O-Ring -10 With a R134 Service Port	7/8" - 18	13mm
AC-1404-R134	-12 Tail Male Pilot O-Ring -12 With a R134 Service Port	1.1/16" - 16	13mm

AC-141x STRAIGHT ONE PIECE FITTING 45° MALE PILOT O-RING

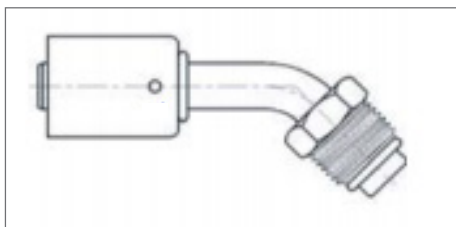

Product Code	Description	Thread
AC-1411	-06 Tail 45° Male Pilot O-Ring -06	5/8" - 18
AC-1412	-08 Tail 45° Male Pilot O-Ring -08	3/4" - 18
AC-1413	-10 Tail 45° Male Pilot O-Ring -10	7/8" - 18
AC-1414	-12 Tail 45° Male Pilot O-Ring -12	1.1/16" - 16
AC-1415	-08 Tail 45° Male Pilot O-Ring -06	5/8" - 18
AC-1418	-06 Tail 45° Male Pilot O-Ring -08	3/4" - 18

AIR CONDITIONING PRODUCTS



AC-142x STRAIGHT ONE PIECE FITTING 90° MALE PILOT O-RING

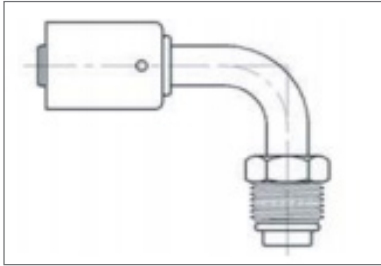

Product Code	Description	Thread
AC-1421	-06 Tail male Pilot O-Ring -06	5/8" - 18
AC-1422	-08 Tail male Pilot O-Ring -08	3/4" - 18
AC-1423	-10 Tail male Pilot O-Ring -10	7/8" - 18
AC-1424	-12 Tail male Pilot O-Ring -12	1.1/16" - 16
AC-1425	-08 Tail male Pilot O-Ring -06	5/8" - 18
AC-1427	-12 Tail male Pilot O-Ring -10	7/8" - 18
AC-1428	-06 Tail male Pilot O-Ring -08	3/4" - 18

AC-290x STRAIGHT ONE PIECE FITTING FLARELESS TUBE COMPRESSION

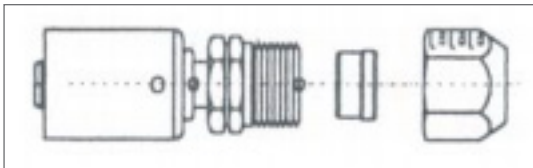

Product Code	Description	Tube
AC-2901	-06 Tail x -06 Flareless Tube Compression	3/8"
AC-2902	-08 Tail x -08 Flareless Tube Compression	1/2"
AC-2903	-10 Tail x -10 Flareless Tube Compression	5/8"
AC-2904	-12 Tail x -12 Flareless Tube Compression	3/4"
AC-2905	-08 Tail x -06 Flareless Tube Compression	3/8"
AC-2906	-10 Tail x -08 Flareless Tube Compression	1/2"
AC-2907	-12 Tail x -10 Flareless Tube Compression	5/8"
AC-2908	-06 Tail x -08 Flareless Tube Compression	1/2"
AC-2909	-08 Tail x -10 Flareless Tube Compression	5/8"

AC-610x-R STRAIGHT ONE PIECE FITTING SPLICER WITH SERVICE PORT

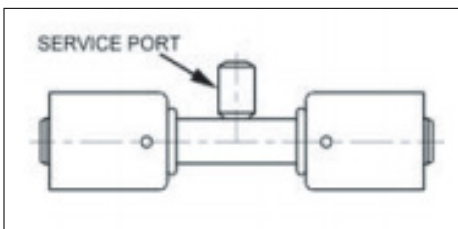

Product Code	Description	Service Port
AC-6101-R12	Splicer With R12 Service Port -06 Tail x -06 Tail	1/4"
AC-6102-R12	Splicer With R12 Service Port -08 Tail x -08 Tail	1/4"
AC-6103-R12	Splicer With R12 Service Port -10 Tail x -10 Tail	1/4"
AC-6104-R12	Splicer With R12 Service Port -12 Tail x -12 Tail	1/4"
AC-6101-R134	Splicer With R134 Service Port -06 Tail x -06 Tail	16mm
AC-6102-R134	Splicer With R134 Service Port -08 Tail x -08 Tail	16mm
AC-6103-R134	Splicer With R134 Service Port -10 Tail x -10 Tail	13mm
AC-6104-R134	Splicer With R134 Service Port -12 Tail x -12 Tail	13mm

AIR CONDITIONING PRODUCTS



AC-110x

STRAIGHT ONE PIECE FITTING
FEMALE FLARE

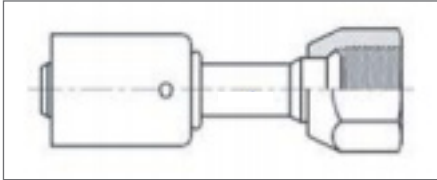

Product Code	Description	Thread
AC-1101	-06 Tail x -06 Female Flare	5/8" - 18
AC-1102	-08 Tail x 08 Female Flare	3/4" - 16
AC-1103	-10 Tail x -10 Female Flare	7/8" - 14
AC-1104	-12 Tail x -12 Female Flare	1.1/16" - 14

AC-111x

STRAIGHT ONE PIECE FITTING
45° BY A FEMALE FLARE

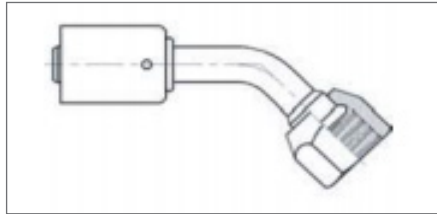

Product Code	Description	Thread
AC-1111	-06 Tail 45° x -06 Female Flare	5/8" - 18
AC-1112	-08 Tail 45° x 08 Female Flare	3/4" - 16
AC-1113	-10 Tail 45° x -10 Female Flare	7/8" - 14
AC-1114	-12 Tail 45° x -12 Female Flare	1.1/16" - 14

AC-112x

STRAIGHT ONE PIECE FITTING
90° BY A FEMALE FLARE

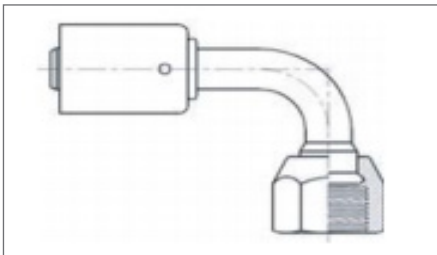

Product Code	Description	Thread
AC-1121	-06 Tail 90° x -06 Female Flare	5/8" - 18
AC-1122	-08 Tail 90° x 08 Female Flare	3/4" - 16
AC-1123	-10 Tail 90° x -10 Female Flare	7/8" - 14
AC-1124	-12 Tail 90° x -12 Female Flare	1.1/16" - 14

CABLE TIES

INCLUDING STAINLESS STEEL TIES AND INSTALLATION GUNS



Description :

- All Nylon one piece construction
- Min. loop tensile strength ranging from 17.8lbs to a maximum of up to 251.3lbs.

Product Range:

- Individual packs
- Mixed pack

Applications:

- A common and useful product for location of hoses in their operating environment
- Use to secure and restrain hose movement to avoid damage through abrasion
- Ideal for urgent small repairs or bundling automotive hoses or electrical cables
- Always take care when using cable ties - consider the application carefully and heed sound installation guidelines.



INDIVIDUAL PACKS			
Product Code Cable Ties	Pack Quantity	Dimensions inch	Min. Tensile Strength
Nylon			lbs
CT-03-18-100*	100	3.93in x 0.09in	17.8
CT-05-40-100*	100	5.90in x 0.13in	40.0
CT-07-50-100	100	7.87in x 0.18in	50.0
CT-11-50-100	100	11.8in x 0.18in	50.0
CT-14-50-100	100	14.5in x 0.18in	50
CT-14-120-50	50	15.0in x 0.30in	120.0
CT-16-175-100*	100	16.9in x 0.35in	175.0
CT-20-175-100*	100	20.9in x 0.31in	175.0
CT-22-251-100*	100	22.8in x 0.51in	251.3
CT-29-175-100*	100	29.9in x 0.35in	175.0
CT-32-175-100	100	32.6in x 0.35in	175.0
CT-40-175-100*	100	40.1in x 0.35in	175.0
CT-48-175-100*	100	48.0in x 0.35in	175.0

Colored Cable Tie Kit	
Product Code	Quantity
CT-POUCH-300	300

* Special order, consult local PIRTEK Service Center also available in blue, green, red, yellow, orange, pink, purple.
Add BL, G, R, Y, OR, P, PU Suffix to Product Code



This page is part of a complete catalog containing technical and safety data.
All data must be reviewed when selecting a product.
PIRTEK reserves the right to change technical specifications without notice.

HOSE TIE STRAPS

FOR BUNDLING HOSES

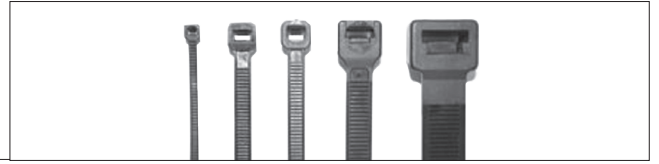

FRAS treated nylon

Description :

- Made from FRAS treated Nylon webbing
- 1 inch wide

Product Range:

- Available in 31.5 inch and 59 inch lengths
- Other lengths and widths to special request (100 pcs. minimum order)
- PIRTEK branded or unbranded

Applications:

- Bundling hose assemblies on drilling, mining and earthmoving equipment
- Coils of hose in service vans and workshops
- Strapping hoses to equipment framework

HOSE TIE STRAP (FRAS)		
Product Code		Dimensions
Branded	Unbranded	mm
HTS800 †	HTSP800	31.5in X 1in
HTS1500 †	HTSP1500	59.0in X 1in

† Available on request

KITS

CAP AND PLUG KITS & O-RING KITS

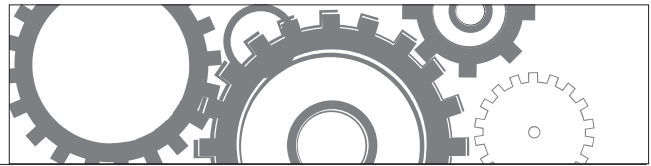

CPK CAP AND PLUG KITS

JIC, ORFS, BSPP, METRIC L/S



Product Code	Description	Kit Quantity
CPK-JIC	JIC Cap and Plug Kit Ranging from -04 to -16	24
CPK-ORFS	ORFS Cap and Plug Kit Ranging from -04 to -16	24
CPK-BSP	BSPP Cap and Plug Kit Ranging from -04 to -16	20
CPK-L	Metric DKOL Cap and Plug Kit Ranging from 6L to 28L	45
CPK-S	Metric DKOL Cap and Plug Kit Ranging from 6S to 25S	42

- JIC kit meets SAE J514 Standards
- ORFS kit meets SAE J1453 Standards
- BSPP kit Compatible with ISO 8434-6 and BS 5200 Standards
- CPK-L and S meets DIN 2353 Standards
- All of the CPK kits are Trivalent Chromium Plated

O-RING KIT-I & KIT-M

AS568 STANDARD BUNA 70



Product Code	Description	Kit Quantity
KIT-I	Assorted Imperial Buna O-Ring Kit, 30 Different Sizes	382
KIT-M	Assorted Metric Buna O-Ring Kit, 30 Different Sizes	382

- Assorted AS568 O-Rings
- Contains 30 of the most commonly used O-Rings within the kit
- Buna-N 70 durometer
- Temperature range from Min -40°F to Max 230°F

ORK-C4 O-RING KIT

STANDARD BUNA 90

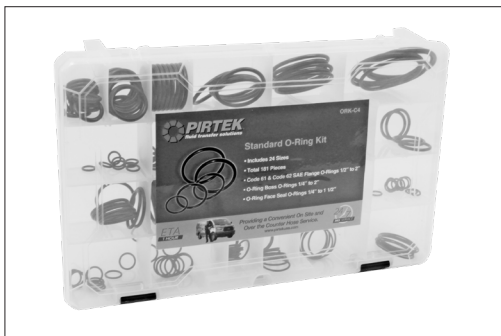

Product Code	Description	Kit Quantity
ORK-C4	Assorted Standard Buna 90 O-Ring Kit, Includes 24 sizes	181

- Code 61 & Code 62 SAE Flange O-Rings from 1/2" to 2"
- UN-O (Oring Boss) O-Rings from 1/4" to 2"
- O-Ring Face Seal (ORFS) from 1/4" to 1.1/2"
- Buna-N 90 durometer
- Temperature range from Min -30°F to Max 250°F



This page is part of a complete catalog containing technical and safety data. All data must be reviewed when selecting a product. PIRTEK reserves the right to change technical specifications without notice.

PLUG KITS

REUSABLE PLUGS

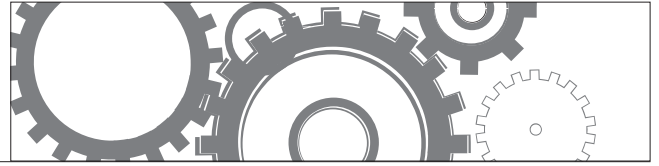

PLDV PLUGS

REUSABLE LIQUID, DUST AND VACUUM PLUGS



Product Code	Description	Package Quantity
PLDV-08	1/8" to 1/2" Reusable Liquid, Dust, Vacuum Plug	6
PLDV-16	1/2" to 1" Reusable Liquid, Dust, Vacuum Plug	6
PLDV-32	1" to 2" Reusable Liquid, Dust, Vacuum Plug	2

- Reusable feature provides valuable savings
- Unique taper design enables the plug to fit a wide range of sizes
- Help save time by eliminating the search for the right size plug
- Controls the weeping of fluids onto the floor and eliminates soil pollution
- Help reduce hydraulic oil spills while the system is being serviced
- Minimum temperature of -40°F and maximum temperature of 210°F
- GO GREEN by reducing soil pollution and landfill contamination

OIL SPILL KITS

ABSORBENT PADS AND SOCKS

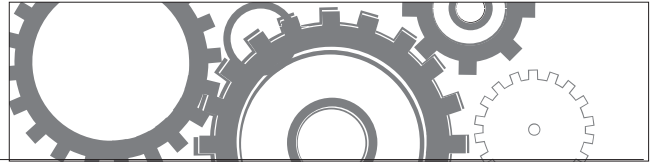

PRK-01

OIL SPILL KIT



Product Code	Description
PRK-01	Oil Spill kit, contains gloves, absorbent socks, absorbent pads, bag and bag tie

- This spill kit is designed to absorb oil, gasoline and other petroleum based fluids
- Dimpled pads increases strength and durability
- The pads can be used on hard surfaces for absorbing oil or for wiping down equipment in the field
- The oil socks are ideal for containing the spill by absorbing and reducing the size of the spill by acting as a containment barrier

Kit contains: 1 pair of gloves, 3 Absorbent socks, 10 Absorbent pads, a containment bag and a bag tie

FLUID POWER GLOVE

FLUID POWER INJECTION SAFETY GLOVE

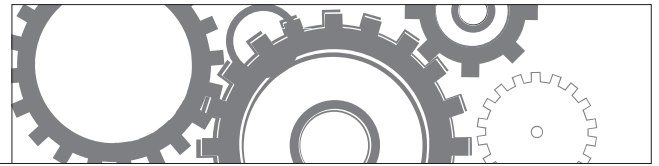

FPG

FLUID POWER INJECTION SAFETY GLOVE



ANSI Puncture tested in accordance with clause 6.4 of EN 388:2003

Supplemental test for fluid injection resistance: This product has been independently tested by the Heath & Safety Laboratory to prove it is as resistant barrier to skin penetration by standard hydraulic mineral oil against pressures of up to 10,150 PSI (700 bar) using skin simulant in direct contact with apertures ranging from 0.002" to 0.012" (0.05mm to 0.3mm)

ATTRIBUTES

Style:	Fluid Injection Resistant
Grip:	Dry or light oil
Cuff Style	Elastic
Sizes	8/M through 11/XXL

Product Code	Description
FPG-08	Fluid power safety glove medium
FPG-09	Fluid power safety glove large
FPG-10	Fluid power safety glove extra large
FPG-11	Fluid power safety glove XX large

- Additional protection includes:
- Abrasion resistance
 - Blade and cut resistance
 - Tear and Puncture resistance

The PIRTEK Fluid Power Glove is an ideal product for those who work on or with equipment powered by hydraulic and other high pressure systems. Rigorous testing shows the PIRTEK Fluid Power Glove is the only hand protection available in the market to protect against fluid injection injuries up to 10,150psi (700bar). The gloves unique SuperFabric® demonstrated injection resistance from apertures ranging in size from 0.002" to 0.012" (0.05mm to 0.3mm) using standard hydraulic oil. The gloves needlestick resistance provides protection in the palm of the hand and fingers by the 3 layers of SuperFabric® brand material.



Using a measuring tape, measure the circumference around the knuckles excluding your thumb. Your hand should be open with the fingers together. If you do not have a measuring tape you can use a piece of string in its place and then use a ruler to measure the string. Compare the measurement to the chart to determine your glove size.

8/M	9/L	10/XL	11/XXL
8-8.5" 20-21.5 cm	8.5-9" 21.5-23 cm	9-10" 23-25 cm	10-11" 25-28 cm

HOSE CLEANING GUNS, PROJECTILES & KITS



PHCK-S

Covers all sizes from 1/4" to 2"

PHCK-V

(Not illustrated)

Covers all sizes from 1/4" to 1.1/4"



IMPORTANT USAGE NOTE:
Hoses must be cleaned **FROM BOTH ENDS** by use of the appropriate pellet **BEFORE** installing the fittings

Description:

The PIRTEK hose cleaning kit is the ideal choice for high volume cleaning of hydraulic hoses, as well as dry and liquid flow lines. The unit shoots oversized foam projectiles to clean straight, curved and coiled tubes, hoses 3/16"-2" (4.8-51mm) I.D. A hinged nozzle housing allows rapid loading of projectiles for fast throughput of large cleaning jobs

Mobile Solution:

For applications where larger hose sizes are not encountered, a smaller kit catering for sizes up to 1.1/4" is available (PHCK-V)

Special Situations:

A wide range of special projectiles are available to special order for special situations

Examples include:

Abrasive: Hose, tube or pipe with build up of contamination, surface rust or scale.

Grinding: Straight lengths of tube or pipe with greater build up of contamination, surface rust or scale

PIRTEK HOSE CLEANING - STANDARD HOSE CLEANING PELLETS

Product Code	Description	Qty per Bag	Suits Hose ID
			ins
PCP-04	STANDARD PELLETT - 7 mm	100	1/4"
PCP-06	STANDARD PELLETT - 12 mm	100	3/8"
PCP-08	STANDARD PELLETT - 16 mm	100	1/2"
PCP-12	STANDARD PELLETT - 22 mm	50	5/8", 3/4"
PCP-16	STANDARD PELLETT - 33 mm	40	1"
PCP-20	STANDARD PELLETT - 40 mm	30	1.1/4"
PCP-24	STANDARD PELLETT - 50 mm	20	1.1/2"
PCP-32	STANDARD PELLETT - 60 mm	15	2"



THREAD IDENTIFICATION AND TOOL KITS

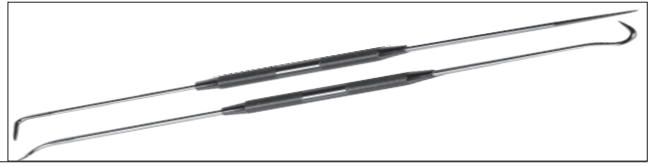

TIK THREAD IDENTIFICATION KIT



Product Code	Description
TIK	Thread Identification Kit

Description

- An all-in-one solution that addresses the need for a simplified guide to identifying the wide range of hydraulic fittings in common use world wide

Advantages

- Most kits simply list the various fitting types and give a run-down on their identifying characteristics. With these, identifying an unfamiliar thread involves searching through page after page of technical data.
- PIRTEK's Kit adopts a more logical approach. Simply choose which picture(s) most closely resemble the unknown fitting, and you will be directed to a small selection of fittings that represent the most likely candidates, along with the page numbers on which they appear in detail.

Contents

- The Tools You Need
- 3 Steps to Success
- Pictorial Guides
- BSP / JIC / UNO
- SAE / NPT / ORFS
- Flanges
- Metric Ports & Studs
- Metric Compression
- Millimetre / GAZ
- Metric Face Seal (Chinese)
- JIS Metric & BSP
- Banjos Metric & BSP
- Staplelok / Super Staplelok
- SKV / SSKV
- Handy Tips / Variations

PRESSURE WASHERS

GUNS, NOZZLES & COUPLINGS

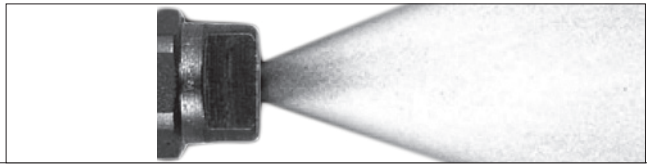

PWNx

PRESSURE WASHER NOZZLES



Coupler Nozzle			Merge this column with the left one	
Product Code	Orifice (inch)	Nozzle	Nozzle Color	Type
PWNR-00	0.040"	0°	Red	Blasting
PWNY-15	0.040"	15°	Yellow	Chiseling
PWNG-25	0.040"	25°	Green	Flushing
PWNW-40	0.040"	40°	White	Wash

- Stainless Steel
- Rated to 3625 psi
- Mates with PWB2-04 Coupler

PRESSURE WASHERS

GUNS, NOZZLES & COUPLINGS

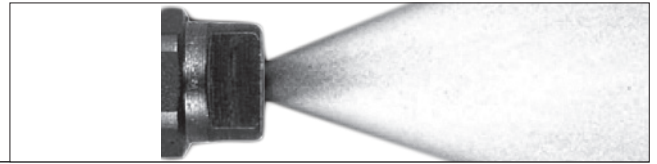

PWTN4000xx

ROTATING TURBO NOZZLE



Light Blue Turbo Nozzle (1160 - 4000 psi)		
Product Code	Color Code	Orifice (inch)
PWTN4000-40	Light Blue	0.040"
PWTN4000-45	Light Blue	0.045"
PWTN4000-50	Light Blue	0.050"

- Concentrated stream in a conical pattern
- Inlet 1/4" NPT Female Thread

IPW-26.0250

M22 STANDARD CONNECTOR NUTS



M22 Standard Connector Nuts		
Product Code	Metric Thread	NPT Thread
IPW-26.0250.20†	M22 x 1.5	1/4" Female
IPW-26.0250.30†	M22 x 1.5	1/4" Male
IPW-26.0250.40†	M22 x 1.5	3/8" Female
IPW-26.0250.50†	M22 x 1.5	3/8" Male

† Available on request

- All examples use a M22x 1.5 metric thread and incorporate a 14 mm pin of standard length
- NPT adapter threads as tabulated
- Suit flow rates to 10.5 gallons / min
- Rated pressure 3625 psi (max. 4061 psi)

PRESSURE WASHERS

GUNS, NOZZLES & COUPLINGS

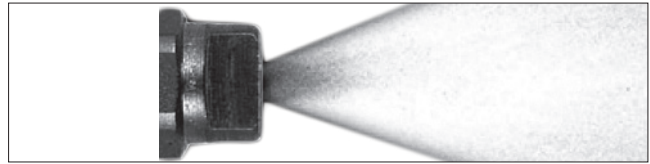

IPW-26.1032

M22x1.5 TYPE A EXTENDED NIPPLE



M22 Extended Pin Adapter Nipples

Product Code	Metric Thread	NPT Thread
IPW-26.1032.31†	M22 x 1.5	1/4" Fem

† Available on request

- M22x 1.5 metric thread to accommodate an extended length 14 mm pin
- 1/4" NPT female adapter thread
- Suit flow rates to 10 gallons / min
- Rated pressure 3625 psi (max. 4061 psi)

IPW-26.1034

M22 EXTENDED CONNECTOR NUTS



M22 Standard Connector Nuts

Product Code	Metric Thread	NPT Thread
IPW-26.1034.20†	M22 x 1.5	1/4" Female
IPW-26.1034.50†	M22 x 1.5	1/4" Male

† Available on request

- M22x 1.5 metric thread incorporating a 14 mm pin of extended length
- NPT adapter threads as tabulated
- Suit flow rates to 10 gallons / min
- Rated pressure 3625 psi (max. 4061 psi)



Example
Extended vs Standard Nipple
Length

PRESSURE WASHERS

GUNS, NOZZLES & COUPLINGS

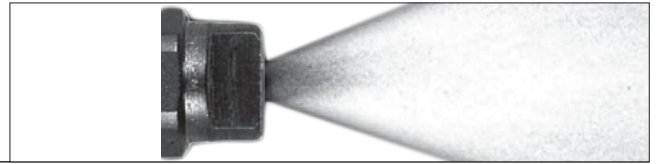

PW2

QUICK COUPLING BODY (TYPE B)



QUICK COUPLING BODY

Product Code	NPT Thread	Body Material
PWB2-06M	3/8" Male	Brass
PWB2-06	3/8" Female	Brass
PWB2-04	1/4" Female	Brass

- Hardened Steel body
- 3625 psi working pressure

PW1

QUICK COUPLING PLUG (TYPE A)



QUICK COUPLING PLUG

Product Code	BSP Thread	Body Material
PWB1-06	3/8" Female	Brass
PWB1-04	1/4" Female	Brass
PWS1-06	3/8" Male	Steel

- Hardened Steel body
- 3625 psi working pressure

PRESSURE WASHERS

GUNS, NOZZLES & COUPLINGS

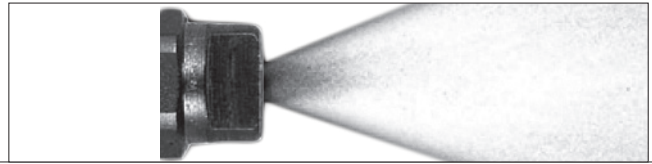

PWG

SPRAY GUNS - 5000 psi max. WP



SPRAY GUNS		
Product Code	Outlet	Inlet Swivel
PWG-04	1/4" NPT Fem	No
PWSG-04†	1/4" NPT Fem	Yes

- † Available on request
- 3/8" NPT female attachment
 - Suit flow rates to 10 gallons / min
 - 5000psi (344 bar) max pressure rating

PWW-36-04

PRESSURE WASH MOLDED GRIP LANCE 36"



Stainless Steel Lance Tube 19in		
Product Code	Length	Pressure
PWW-36-04	36 inches	4000 psi

- 1/4" NPT male threaded ends
- 10 gallons / min flow capacity
- 300°F Max Temperature
- Oval Shape Grip
- Bright Plated Steel Tube

KG

Bend Restrictors - for Hose Ends

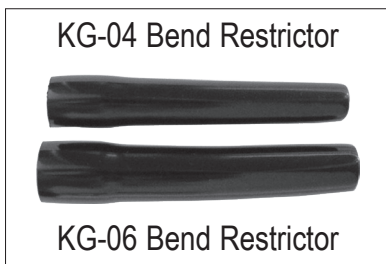

KG-04	Black bend restrictor to suit PW3600-04 Pressure Wash Hose & JK70-04 Jacking Hose
KG-06	Black bend restrictor to suit PW4500 Pressure Wash Hose & JK70-06 Jacking Hose

FCS

STEEL SPRING GUARD

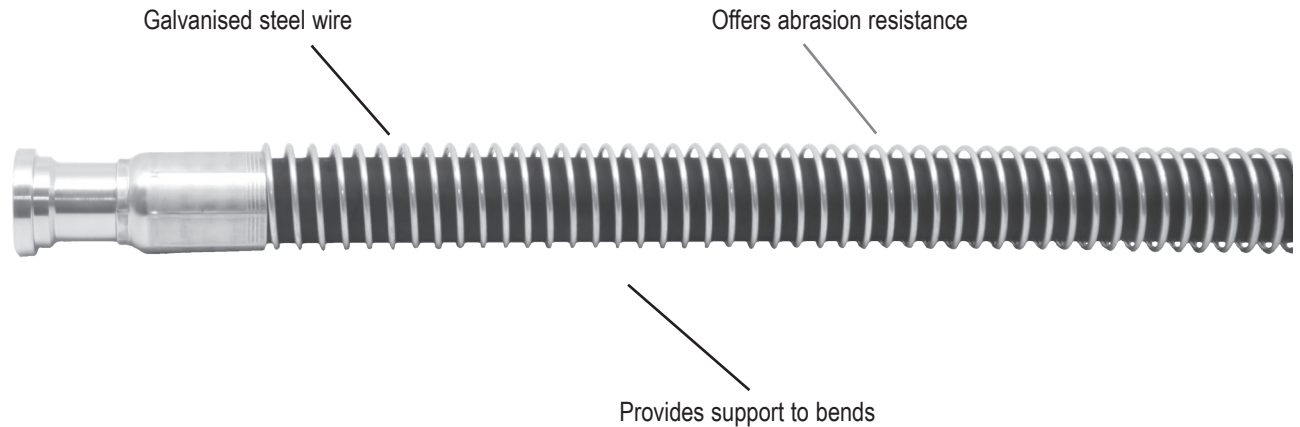

Description:

- Wound heavy gauge galvanised wire ideal for the protection of hose exposed to severe operating conditions
- The wire helps to distribute a bending radius on curved hoses, and reduces the likelihood of kinking
- Helps prevent abrasion and resists deep cuts

Materials and Specifications:

- Galvanised steel wire

Applications:

- Common in quarries as protection from flying stones

STEEL SPRING GUARD						Suits Hose Type & Dash Size				
Product Code	Dimensions mm				Length	R1AT	R2AT	C25 / PC25	C35 / PC35	C42 / PC42
	ID	OD	Wire Ø	Pitch						
FCS-03	13.5	17.5	2.0	5.0	10 FT	-03	-03			
FCS-04	15.6	19.4	2.0	5.0	10 FT	-04	-04		-05	-04
FCS-06	22.0	26.0	2.0	5.0	10 FT	-06	-05, -06		-06	-06
FCS-08	24.8	28.8	2.0	5.0	10 FT	-08	-08		-08	
FCS-10	28.3	34.5	3.0	7.3	10 FT	-10	-10	-10	-10	
FCS-12	33.6	39.7	3.0	7.3	10 FT	-12	-12		12	-12
FCS-16	40.0	45.8	3.0	7.3	10 FT	-16	-16	-16	-16	-16
FCS25-20	48.3	54.2	3.0	7.3	10 FT	-20		-20		
FCS42-20	53.0	59.2	3.0	7.3	10 FT	-24	-20		-20	-20

PHS

ABRASION SLEEVE



Description:

- Black Nylon sleeving for the assistance in protection of people and machinery via protection and bundling of hose, hose assemblies, cables, wires etc.
- Dense yet not bulky protection is achieved through protection of the encased product from abrasion.
- The smooth surface facilitates sliding over even very long assemblies, and use of talcum powder or compressed air will further facilitate the installation process.

Materials and Specifications:

- Compact woven nylon fibres (Polyamide 6)
- Abrasion resistance exceeds the requirements of ISO 6945 (holds up to 50,000 cycles)
- UV stabilized while using carbon black.
- Resistant to mildew and bacterial growth.
- Approved by MSHA for the use in mines.
- Working temperature -40°F to 212°F.
- Melting point 419°F - 430°F.

Applications:

- Widely used as abrasion protection wherever hoses and cables may be exposed to damage through rubbing.
- The sleeve must be secured to the ferrule of the hose fitting if effective protection is to be achieved at the hose to fitting interface.
- A loose fit is preferred when seeking to gain the maximum abrasion resistance from the sleeving.

PIRTEK Hose Sleeve			
Product Code	Nominal ID Inches		Coil Length
	Flat	Round Ø	FT
Black			
PHS-020	1.22 - 1.37	0.82	50 / 300
PHS-025	1.46 - 1.70	1.00	50 / 300
PHS-027	1.66 - 1.90	1.13	50 / 300
PHS-031	2.00 - 2.19	1.33	50 / 300
PHS-036	2.23 - 2.38	1.46	50 / 300
PHS-039	2.38 - 2.62	1.58	50 / 300
PHS-044	2.72 - 2.90	1.78	50 / 300
PHS-055	3.33 - 3.53	2.18	50 / 300

Photo illustrates a optional attachment to the hose ferrule using epoxied heatshrink

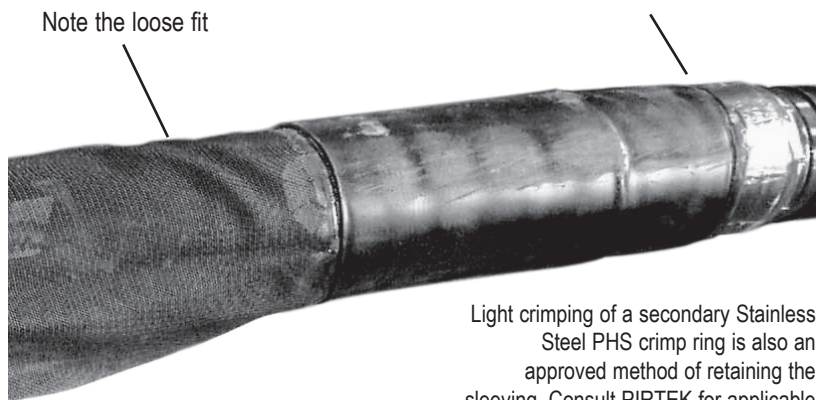

Light crimping of a secondary Stainless Steel PHS crimp ring is also an approved method of retaining the sleeving. Consult PIRTEK for applicable crimp dimensions.

PSAW / FRASG

SPIRAL SAFETY GUARD AND FRAS GUARD



Description:

- Red and Yellow wear indicator highlighting areas of abrasion.
- An ideal and economical hose wrap for individual hoses or for use in bundling.
- Available in an approved fire resistant and anti-static (FRAS) form for use in underground coal mines.
- UV resistant.
- Can be retrofitted on site to existing hoses and bundles while in place.
- Self lubricating properties.
- Exceptional anti-crushing and abrasion resistance.

Materials and Specifications:

- High density polyethylene
- FRAS version Approval No. MSHA IC-213/2
- *Not approved for use on electrical cables*
- Working temperature -60°F to +175°F

Applications:

- Agricultural equipment
- Mining and quarrying
- Oil and gas distribution
- Forestry (color coding available to order)
- Welding hose protection
- Robotic arms and booms
- Transport
- *Not approved for use on electrical cables*



PIRTEK SPIRAL GUARD & FRAS GUARD								Hose Dash Size	Hose Type				Range of Hose OD
Product Code				Dimensions Inches		Box Length	Coil Length		R1AT	R2AT	PC35 / C35	PC42 / C42	
Spiral Guard		Spiral Guard	FRAS Guard †	OD	ID	FT	FT					inch	
Black / Yellow	Black / Red	Box Quantity	Black										
PSAW-16 •	PSAW-16-25B	PSAW-16-25B	FRASG-016BL	16	13	25	100	-04	•	•	•	0.67	
PSAW-19	PSAW-19-25B	PSAW-19-25B	FRASG-020BL	0.75	0.63	25	100	-04 to -08	•	•	•	0.87	
PSAW-25	PSAW-25-25B	PSAW-25-25B	FRASG-025BL	1.00	0.81	25	100	-08 to -10	•	•	•	1.10	
PSAW-35	PSAW-35-20B	PSAW-35-20B	FRASG-032BL	1.25	1.06	20	100	-12	•	•	•	1.30	
PSAW-40	PSAW-40-14B	PSAW-40-14B	FRASG-040BL	1.50	1.36	14	100	-16	•	•	•	1.65	
PSAW-50	PSAW-50-10B	PSAW-50-10B •	FRASG-050BL	2.0	1.70	10	100	-20 to -24	•	•	•	2.16	
PSAW-65 •	-	-	FRASG-063BL	2.50	2.20		50 - 100	-24 to -32		•	•	2.5	
PSAW-75 •	-	-	FRASG-075BL	3.00	2.60		75	-32 to -40	•	•	•	3.25	
PSAW-90 †	-	-	FRASG-090BL	3.50	3.20		50	Hose bundles 3 inch to 6 inch diameter					
PSAW-110 †	-	-	FRASG-110BL-	4.33	3.90		50	Hose bundles above 6 inch diameter					

† Available on request

• Abrasion wear indicator not available in these sizes

PIRTEK WHIP CHECK FOR HYDRAULIC HOSES



Code 61 & Code 62 terminal connection

Connection for multiple applications

Description:

Whip Checks are a retention system designed to stop hoses which have become disconnected from a piece of equipment or through catastrophic failure.

For effective implementation, each whip check assembly must be suited to the specific application requirements.

Whip check cables have been tested for use at pressures up to 6090 psi working pressure (dependent on hose specifications).

Applications:

Used whenever the occurrence of hose fitting blow-off or accidental disconnection of a hose end could endanger the lives of personnel working nearby.

Whip Check Assembly And Installation Guide:

1. Place the Whip Check Hose Clamp at a distance Y equivalent to the length X of the ferrule, so that X=Y. (See fig. 1 and 2 next page)
 2. Fasten the Whip Check Hose Clamp until the internal seal is secured to the exterior of the hose, by tightening the self locking nut; ensuring that the ends of the clamp do not touch the cutting plate. (See fig 3 next page)
 3. When installing the Whip Check System for Code 61 and 62 Flanges ensure that the mounting plate remains secured and correctly positioned after the flange bolt has been tightened. (See fig 1 next page)
 4. When installing the Whip Check System directly to the equipment attach the mounting plate to a steel structure using an M12x25 (UNI 5931 – DIN 912 – ISO 4762) 12.9 grade socket head cap screw at a distance of 250 mm from the hose clamp. Ensure that the mounting plate is secured and positioned correctly. (See fig 2 next page)
- Given environmental conditions such as ultraviolet light, ozone, salt water, chemical agents (solvents, fuels, oils, greases, volatile chemical compounds, acids, disinfectants and other aggressive chemicals) can cause early deterioration of the internal seal.
 - The internal seal must be replaced every 4 years if the hose clamp is not attached to a hose assembly.
 - The internal seal must be replaced every 2 years if the hose clamp is attached to a hose assembly.
 - The Whip Check System must never be re-used in case of hose failure, slip-off or replacement of the hose, as this will jeopardize the safety features of the system.

WHIP CHECK HOSE SELECTION GUIDE

PIRTEK HOSE	HOSE CLAMP PART NUMBER
PC25-10	WCHC-027
PC25-12	WCHC-029
C25-16	WCHC-035
PC25-20	WCHC-047
PC25-24	WCHC-053
C35-08	WCHC-023
PC35-10	WCHC-027
PC35-12	WCHC-029
PC35-16	WCHC-037
PC35-20	WCHC-050
PC35-24	WCHC-056
C21-32	WCHC-065
C35-32	WCHC-071
C42-08	WCHC-023
P42-10	WCHC-026
C42-12	WCHC-031
C42-16	WCHC-039
C42-20	WCHC-050
PC42-24	WCHC-056
100R4-12	WCHC-031
100R4-16	WCHC-039
100R4-20	WCHC-047
100R4-24	WCHC-053
100R4-32	WCHC-062
R1AT-08	WCHC-021
R1AT-10	WCHC-023
R1AT-12	WCHC-028
R1AT-16	WCHC-037
R1AT-20	WCHC-044
R1AT-24	WCHC-050
R1AT-32	WCHC-065
R2AT-08	WCHC-022
R2AT-10	WCHC-025
R2AT-12	WCHC-029
R2AT-16	WCHC-039
R2AT-20	WCHC-050
R2AT-24	WCHC-056
R2AT-32	WCHC-068

WHIP CHECK PRESSURE SELECTION GUIDE

PIRTEK PART NUMBER	PSI	Bar
WCCABLE-105	6090	420
WCCABLE-165	6090	420
WCCABLE-BOLT	6090	420

**A complete whip check assembly is comprised of a two components, the WCHC clamp and a WCCABLE.*



PIRTEK WHIP CHECK FOR HYDRAULIC HOSES

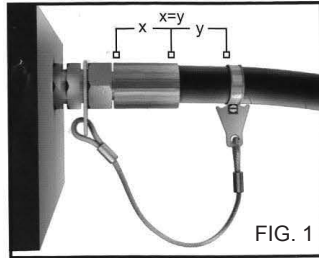

FIG. 1

SELECTION OF WHIP CHECK FOR CODE 61 AND CODE 62 FLANGES

(Figure 1)

Select the Whip Check system according to the diameter of the SAE flange thread ensuring that the maximum operating pressure of the hose and fitting complies with the pressure rating indicated in the Selection Guide.

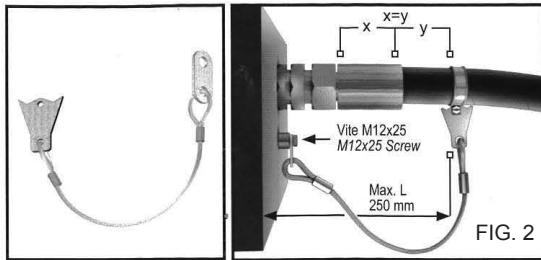

FIG. 2

SELECTION OF WHIP CHECK SYSTEM FOR MULTIPLE APPLICATIONS

(Figure 2)

The Whip Check retention system is used when no coupling system for the nipple or SAE flange is available; in this case the hose shall be retained by coupling it to the equipment ensuring that the maximum operating pressure of the hose and fitting complies with the pressure rating indicated in the Selection Guide.

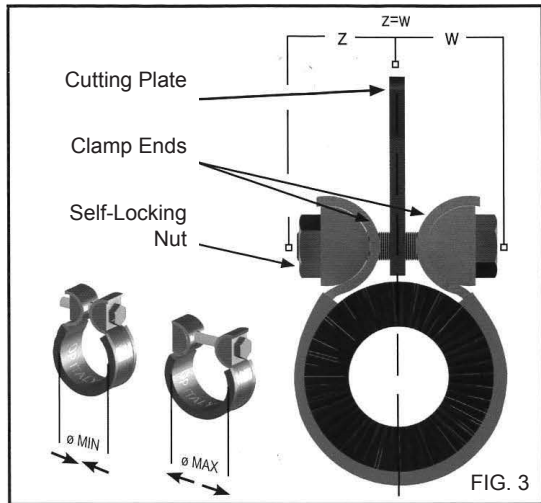

FIG. 3

CHOICE OF CLAMP

(Figure 3)

Select the clamp with maximum and minimum clamp diameters as indicated in the Selection Guide.

